



FRAME GLASS

Divisiones y puertas de paso
Glazed room dividers and doors
Divisions et portes d'accès

 **saheco**
sistemas para puertas correderas



ÍNDICE INDEX INDICE

FRAME SV-X70 6

FRAME SV-X110 24

FRAME GLASS

Frame es un marco perimetral compatible con todos los sistemas de la familia Compact Glass de Saheco.

Con el puedes transformar tus puertas correderas de vidrio en un hogar o comercio elegante, moderno y minimalista.

Adecuado para paneles de vidrio de 10 mm de grosor y un peso de 70 a 110 kg por hoja.

Se ofrece en dos acabados: Aluminio anodizado negro y aluminio anodizado plata mate.

Frame family offers a perimeter frame for glass panels It is compatible with all systems of the Compact Glass family By Saheco.

With Frame, you can transform your gliding glass doors in a modern and minimalist residence or an elegant commerce.

It handles glass panels of 10mm thickness and 70 to 110 kg per panel.

We offer it in two finishes: Black aluminum anodized and in mat silver anodized aluminum.

Frame est un cadre périmétral compatible avec tous les systèmes de la famille Compact Glass de Saheco

Avec Frame, vous pouvez transformer votre Porte coulissante en verre En foyer ou commerce élégant, Moderne et minimaliste.

Adéquat pour panneaux de verre de 10mm d'épaisseur et un poids de 70 à 110 kg par panneau

Nous l'offrons en deux finitions : Aluminium anodisé noir et aluminium anodisé argent mat.plata mate.



Conjunto marco perimetral | Perimeter frame set | Kit de cadre périmétral

TECHO
CEILING
PLAFOND

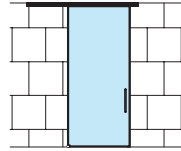

PARED
WALL
MUR

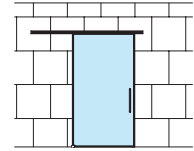

SV-X70



SV-X110



Conjunto división interna | Internal division set | Kit de division interne

TECHO
CEILING
PLAFOND

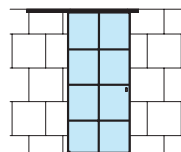

PARED
WALL
MUR

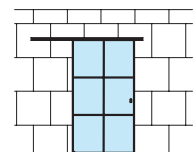

SV-X70



SV-X110



PARED DE VIDRIO
GLASS WALL
MUR DE VERRE

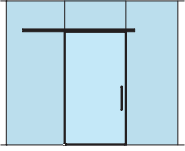

TECHO CON VIDRIO FIJO
CEILING WITH FIXED GLASS
PLAFOND AVEC VERRE FIXE

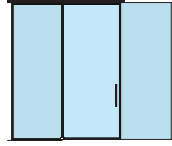

FALSO TECHO
FALSE CEILING
FAUX-PLAFOND

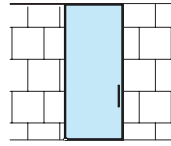

FALSO TECHO CON VIDRIO FIJO
FALSE CEILING WITH FIXED GLASS
FAUX-PLAFOND AVEC VERRE FIXE

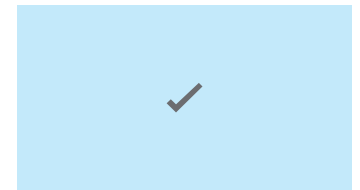
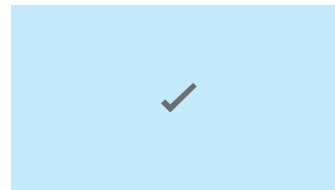
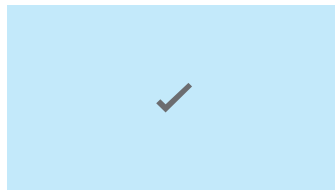
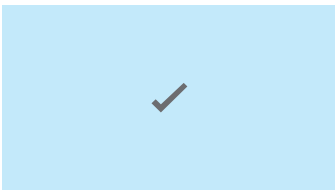
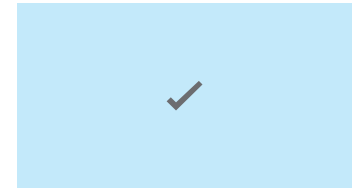
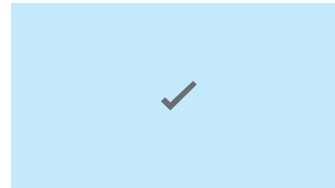
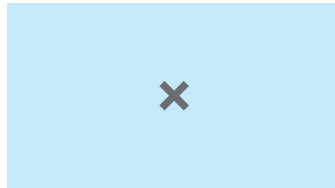
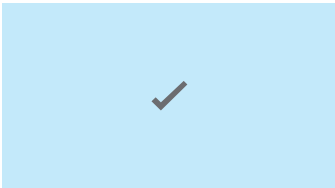
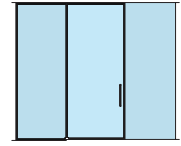

PARED DE VIDRIO
GLASS WALL
MUR DE VERRE

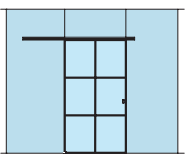

TECHO CON VIDRIO FIJO
CEILING WITH FIXED GLASS
PLAFOND AVEC VERRE FIXE

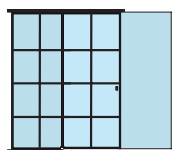

FALSO TECHO
FALSE CEILING
FAUX-PLAFOND

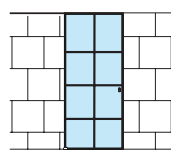

FALSO TECHO CON VIDRIO FIJO
FALSE CEILING WITH FIXED GLASS
FAUX-PLAFOND AVEC VERRE FIXE

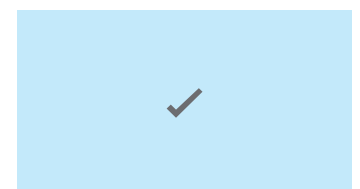
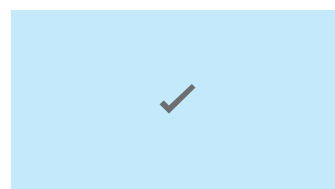
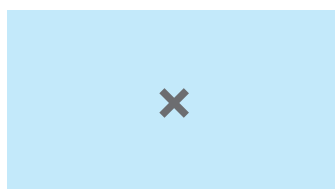
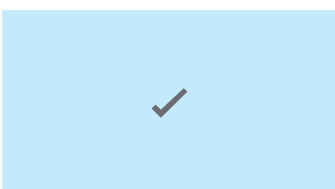
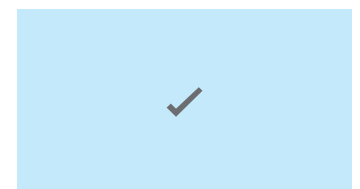
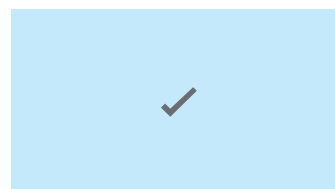
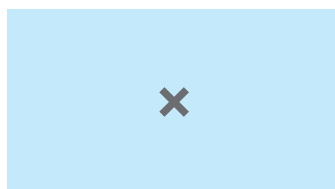
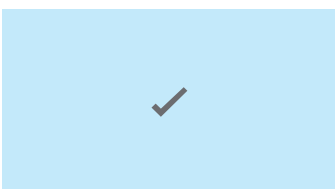
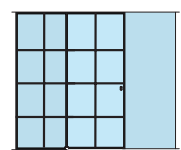

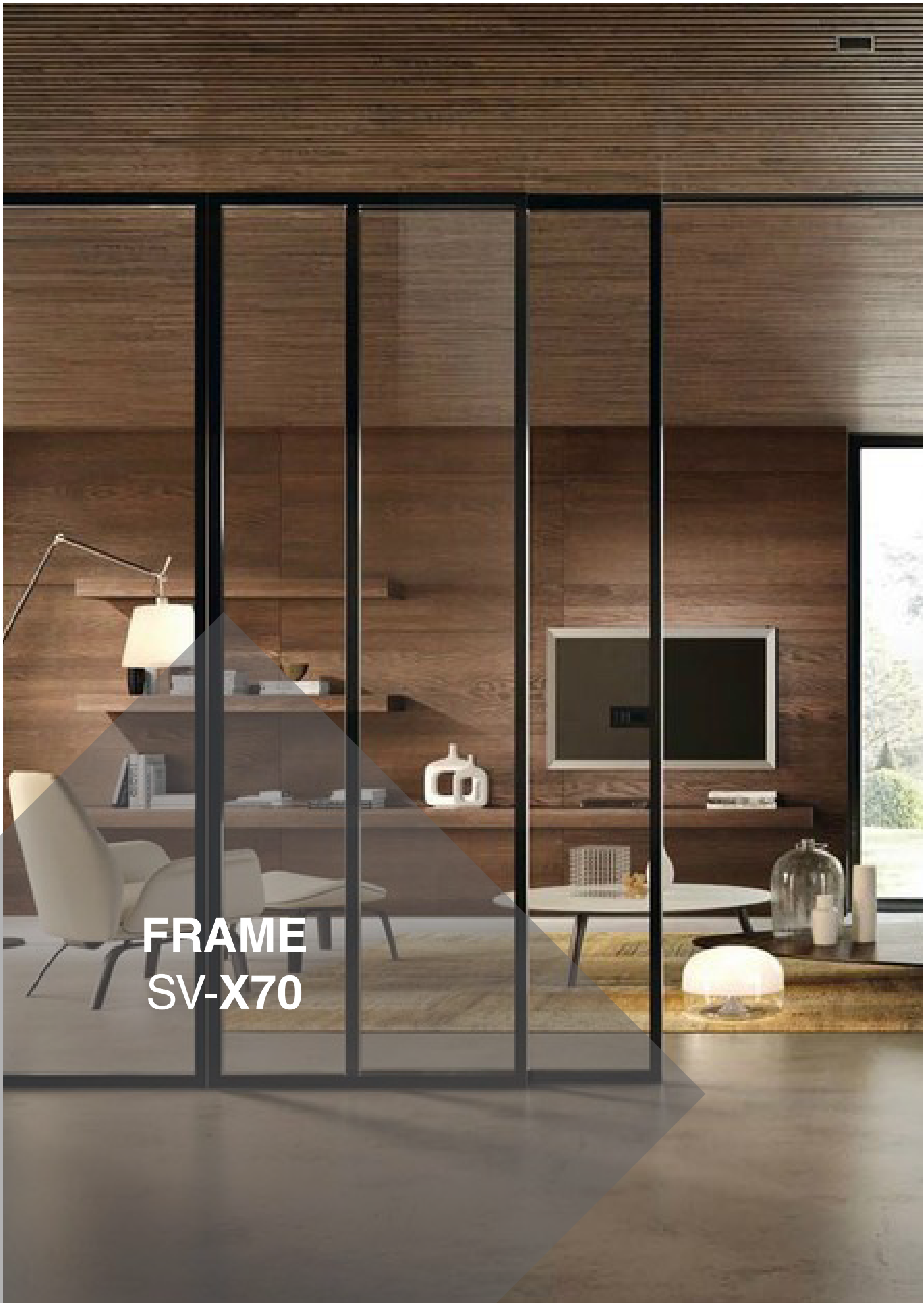

**FRAME
SV-X70**



Pictogramas | Pictograms | Pictogrammes

Perfilería | Profiles | Profils

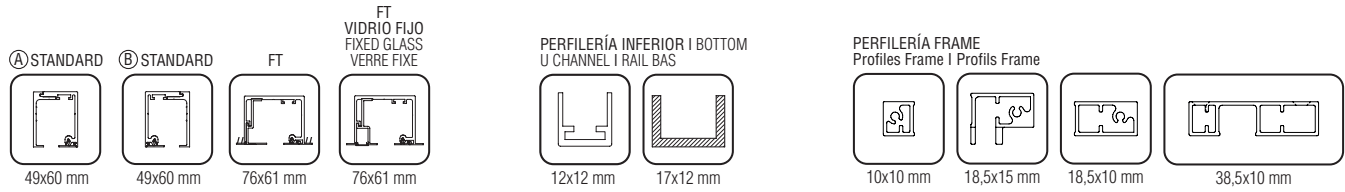

Especificaciones | Specifications | Spécifications

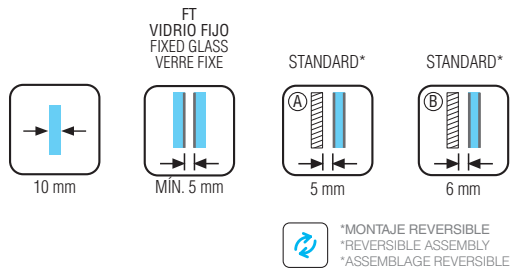

Peso | Weights | Poids



Variantes de instalación | Installation possibilities | Variantes d'installation



Variantes de instalación | Installation possibilities | Variantes d'installation

1 OPCIÓN PUERTA CORREDERA A TECHO | SLIDING DOOR FOR CEILING | PORTE COULISSANTE POUR PLAFOND

Conjunto marco perimetral a techo
 Ceiling perimeter frame set
 Kit cadre périmétral plafond

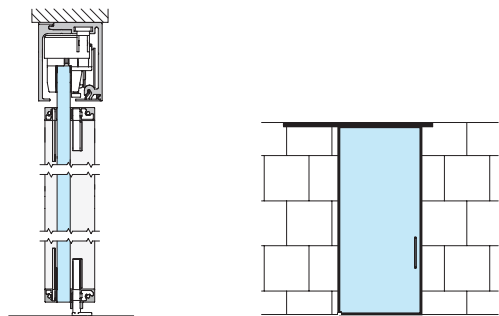

Conjunto división interna a techo
 Ceiling internal division set
 Kit division interne plafond

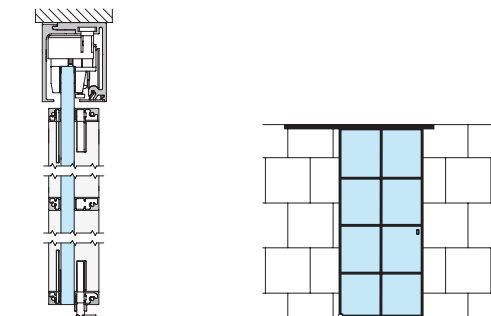

2 OPCIÓN PUERTA CORREDERA A PARED | SLIDING DOOR FOR WALL | PORTE COULISSANTE POUR MUR

Conjunto marco perimetral a pared
 Wall perimeter frame kit
 Kit cadre périmétral mur

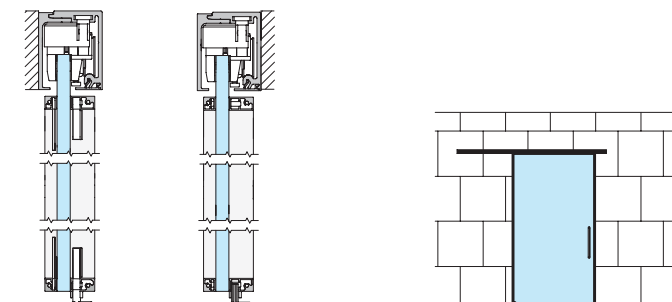

Conjunto división interna a pared
 Wall internal division set
 Kit division interne mur

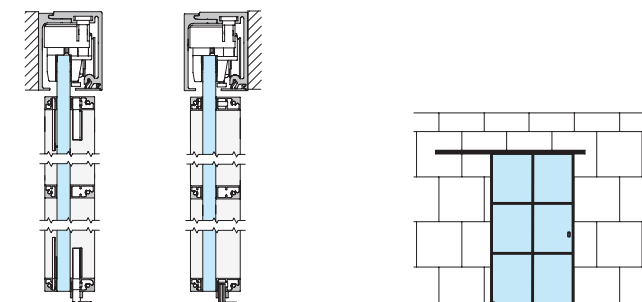

3 OPCIÓN PUERTA CORREDERA A PARED DE VIDRIO | SLIDING DOOR FOR GLASS WALL | PORTE COULISSANTE POUR MUR DE VERRE

Conjunto marco perimetral a pared de vidrio
 Glass wall perimeter frame set
 Kit cadre périmétral mur de verre

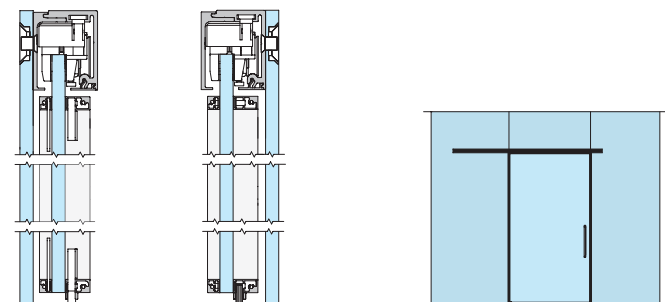

Conjunto división interna a pared de vidrio
 Glass wall internal division set
 Kit division interne mur de verre

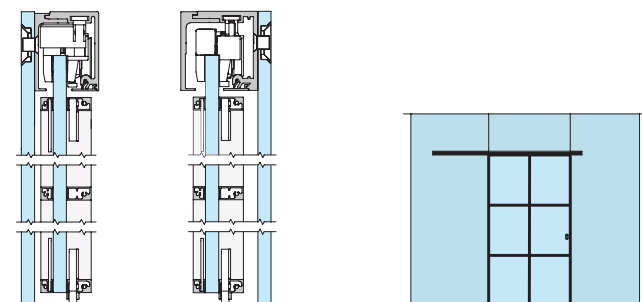

4 OPCIÓN PUERTA CORREDERA A FALSO TECHO | SLIDING DOOR FOR FALSE CEILING | PORTE COULISSANTE POUR FAUX PLAFOND

Conjunto marco perimetral falso techo

False ceiling perimeter frame set
Kit cadre périmétral pour faux plafond

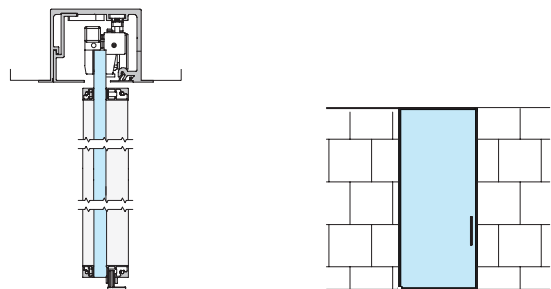

Conjunto división interna falso techo

False ceiling internal division set
Kit division interne pour faux plafond

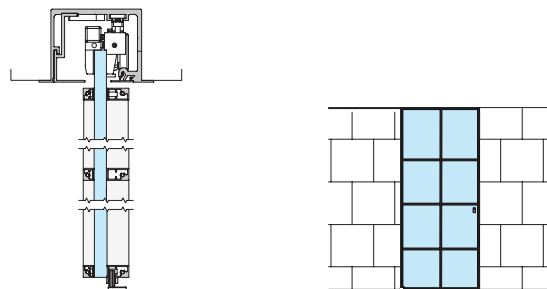

5 OPCIÓN VIDRIO FIJO A FALSO TECHO | FIXED GLASS FOR FALSE CEILING | VERRE FIXE ET FAUX PLAFOND

Conjunto marco perimetral falso techo vidrio fijo

False ceiling with fixed glass perimeter frame set
Kit cadre périmétral pour faux plafond avec verre fixe

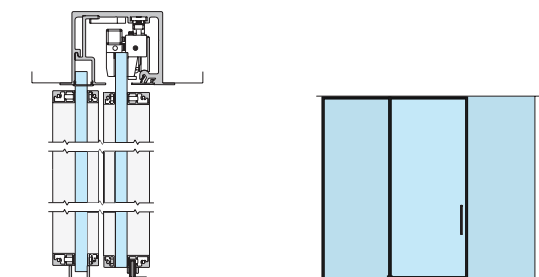

Conjunto división interna falso techo vidrio fijo

False ceiling with fixed glass internal division set
Kit division interne pour faux plafond avec verre fixe

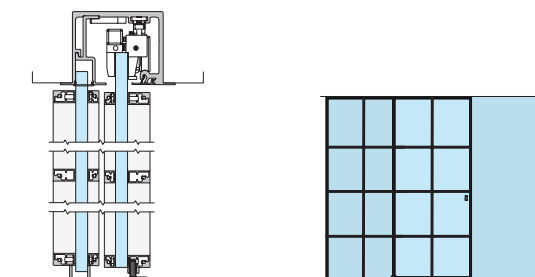

Montaje a pared | Wall mount | Fixation à mur

(Cotas en mm / Dimensions in mm / Dimensions en mm)

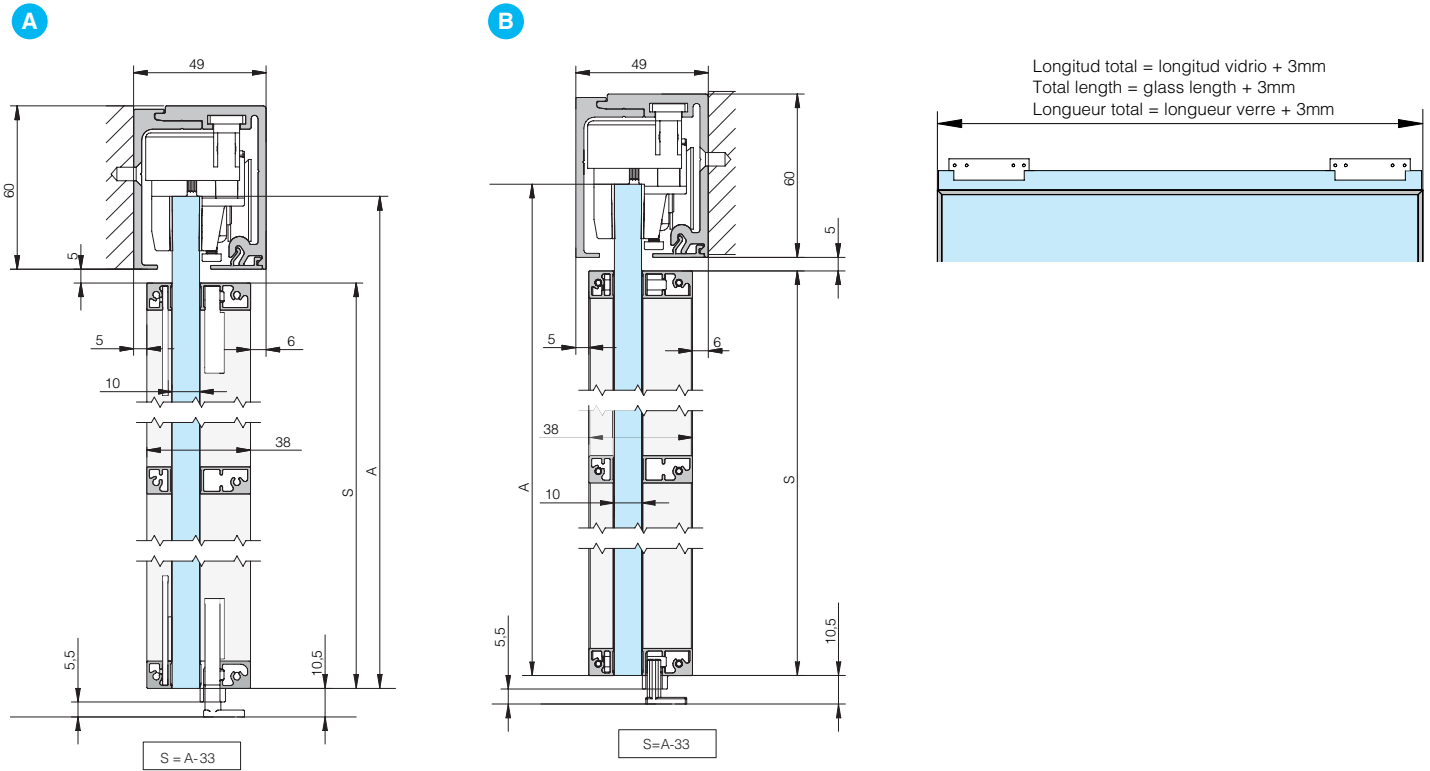

Montaje a techo | Ceiling mount | Fixation a plafond

(Cotas en mm / Dimensions in mm / Dimensions en mm)

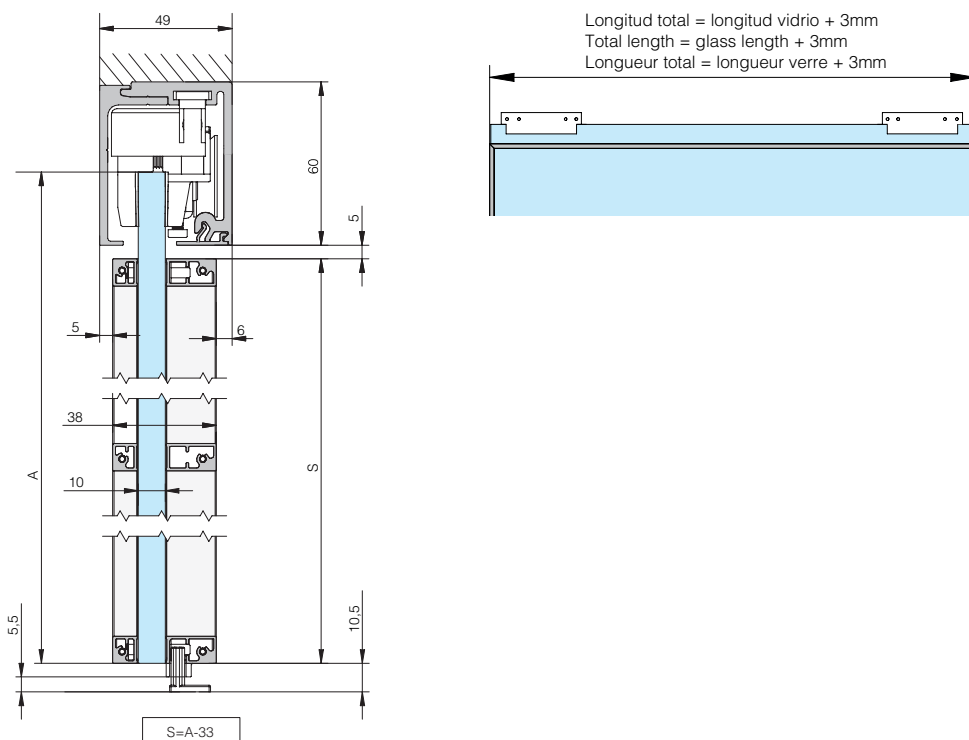

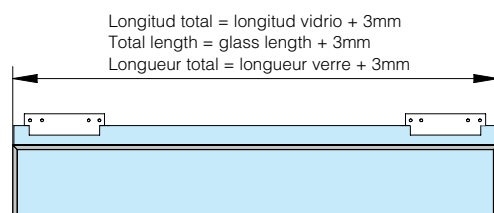
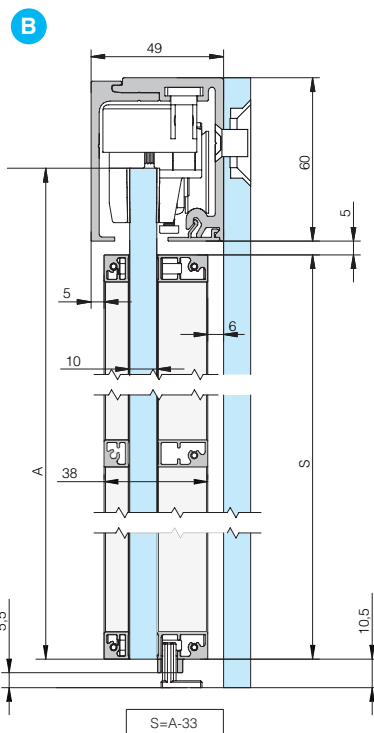
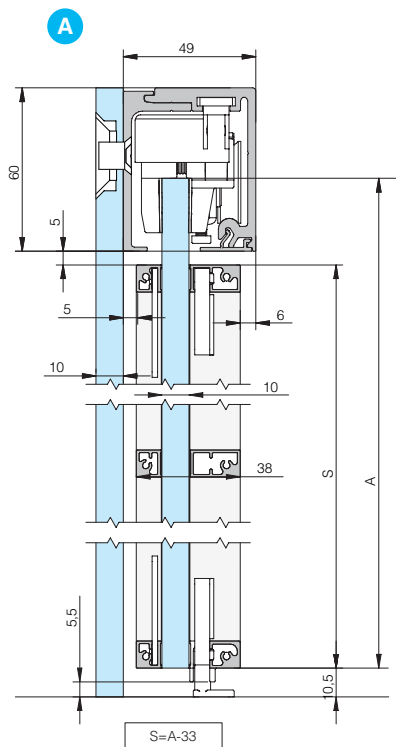

OPCIÓN VIDRIO FIJO | FIXED GLASS OPTION | OPTION VERRE FIXE

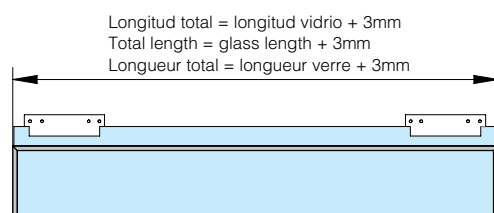
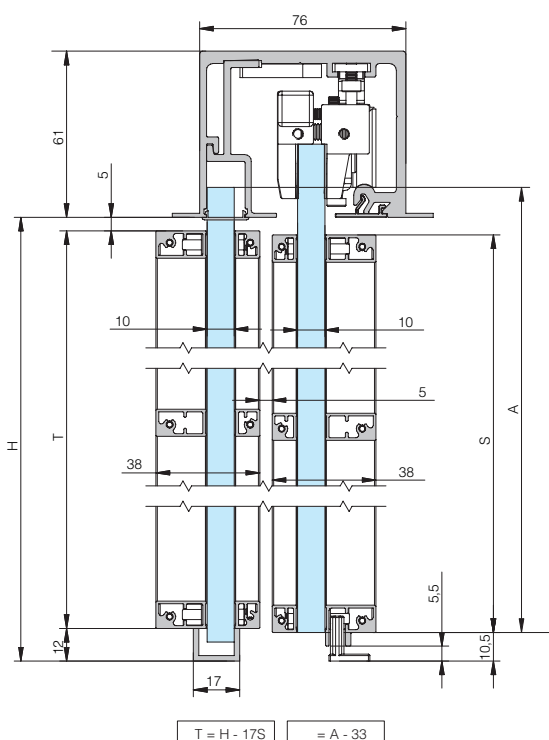
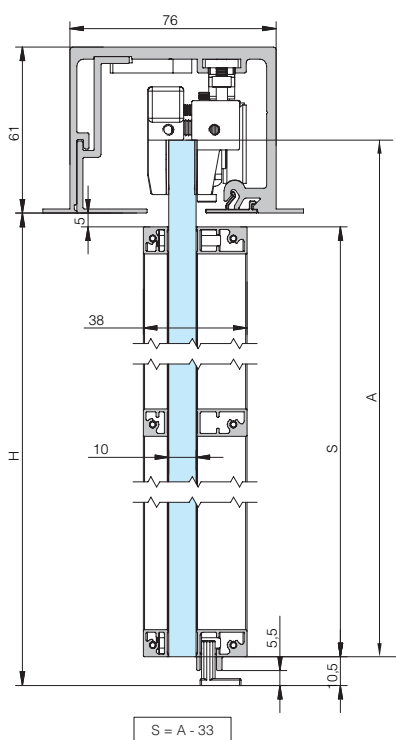

Puerta corredera a techo y a pared | Sliding door for ceiling and wall | Porte coulissante pour plafond et mur

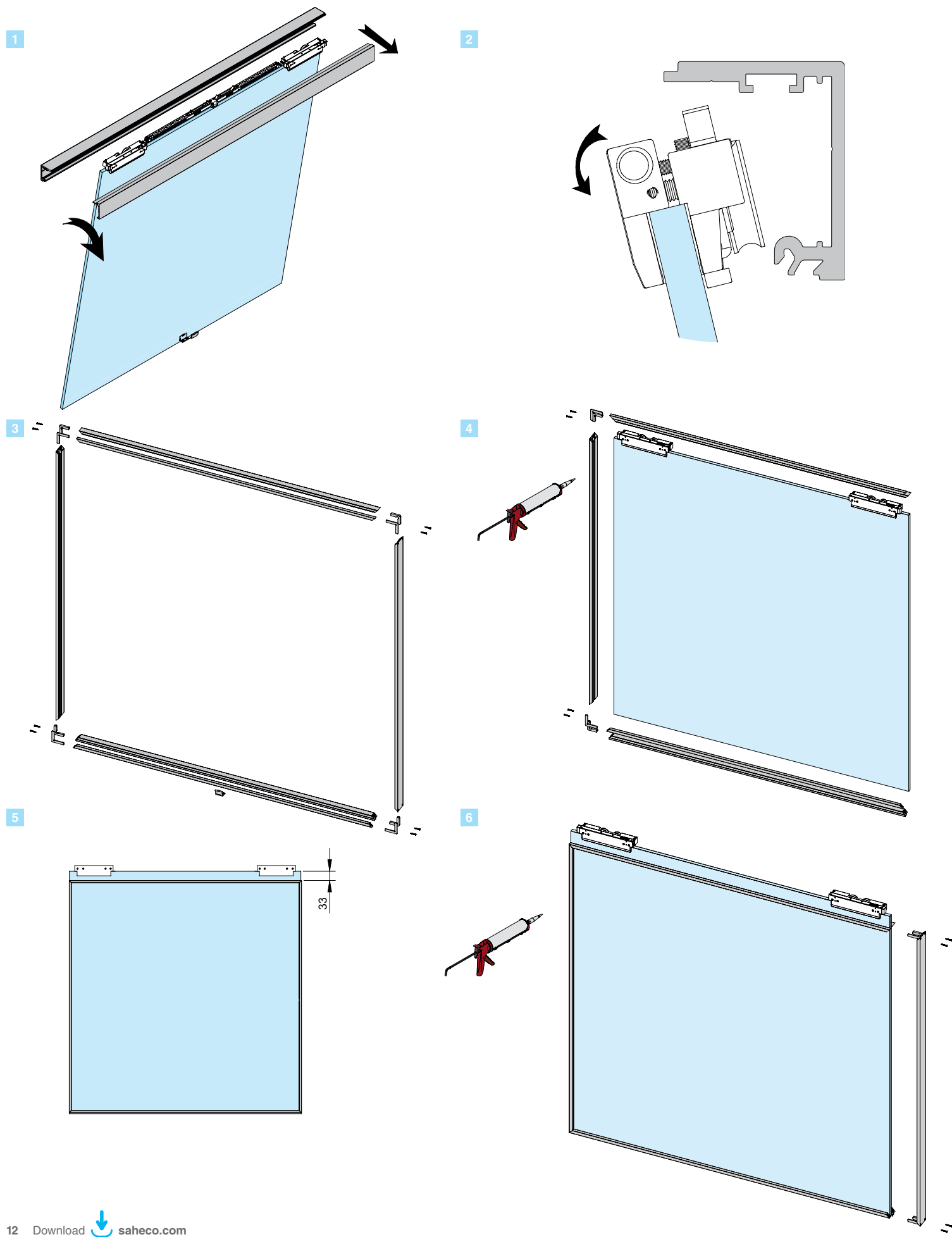

Falso techo vidrio fijo | False ceiling with fixed glass | Faux plafond avec verre fixe

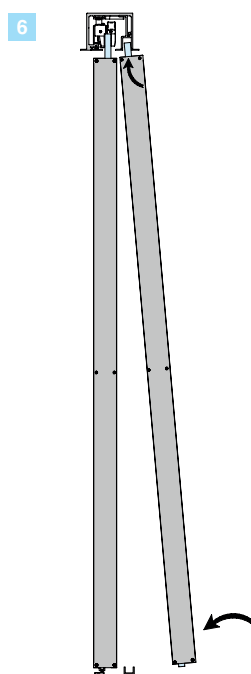
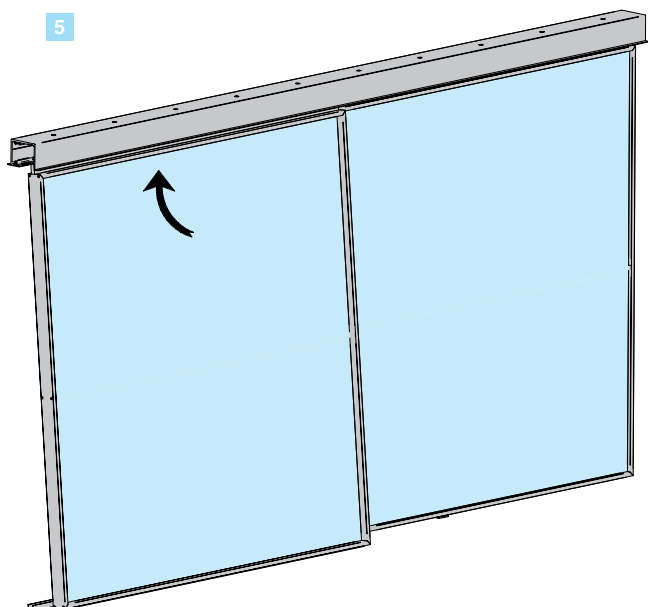
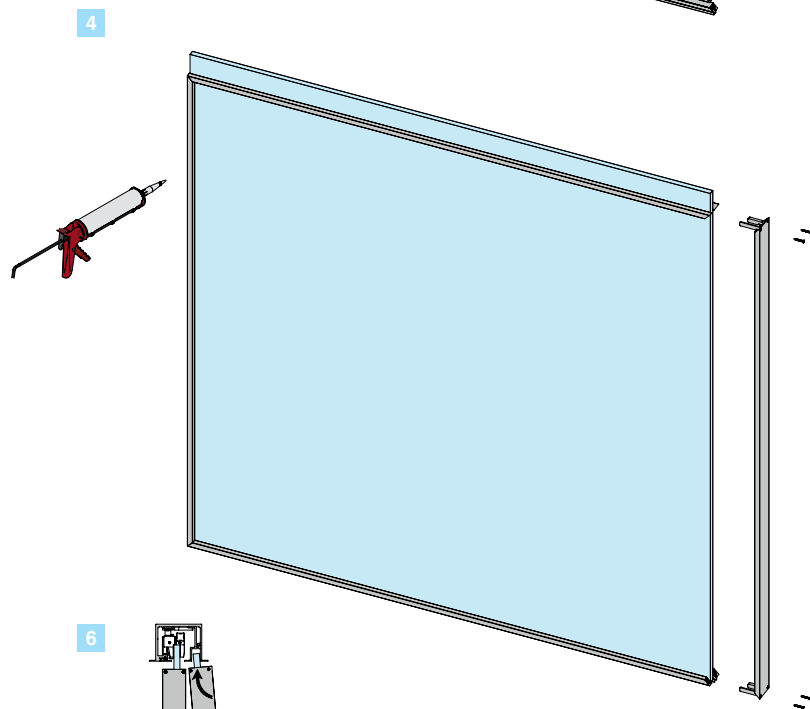
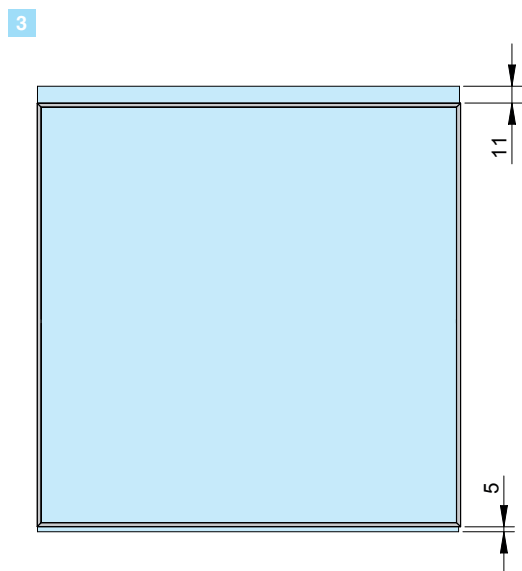
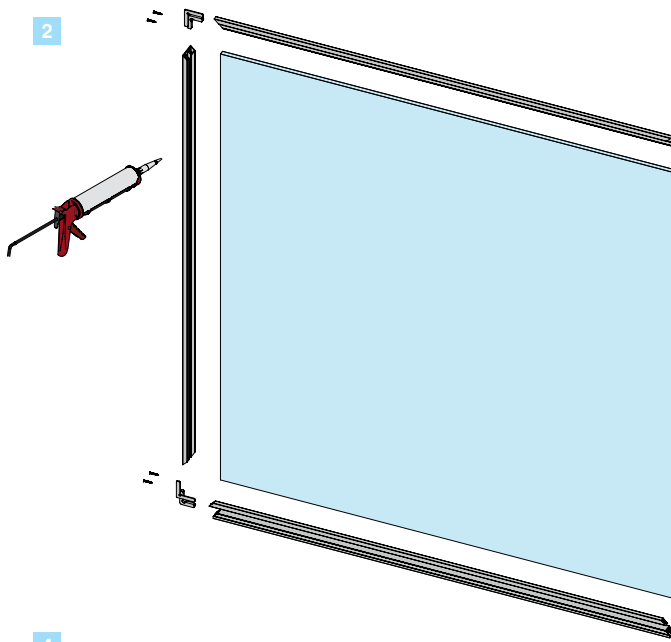
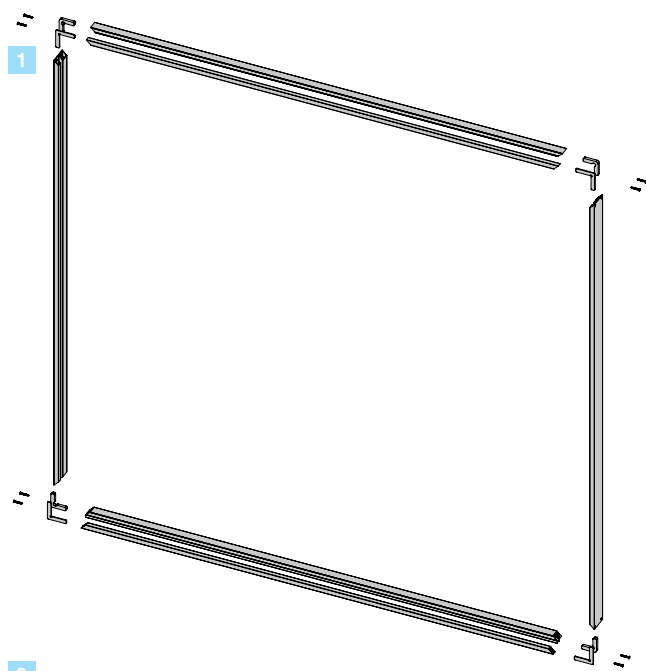

División interna | Internal division | Division interne

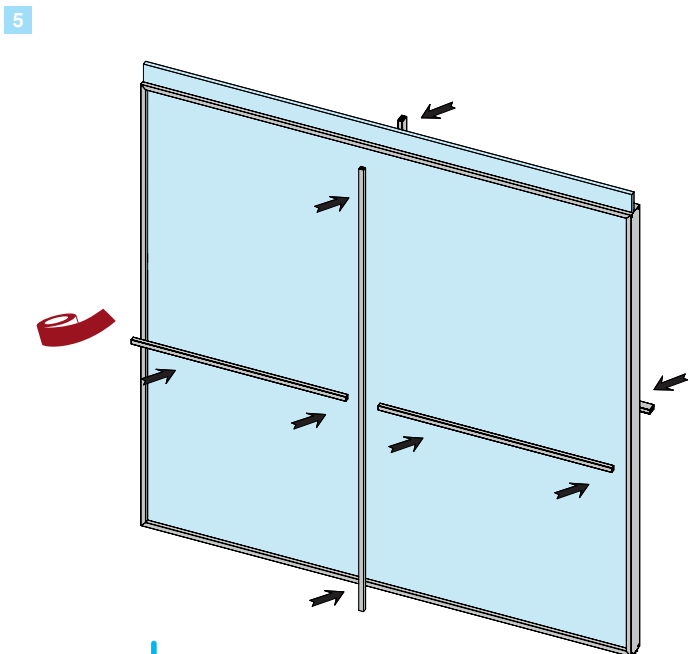
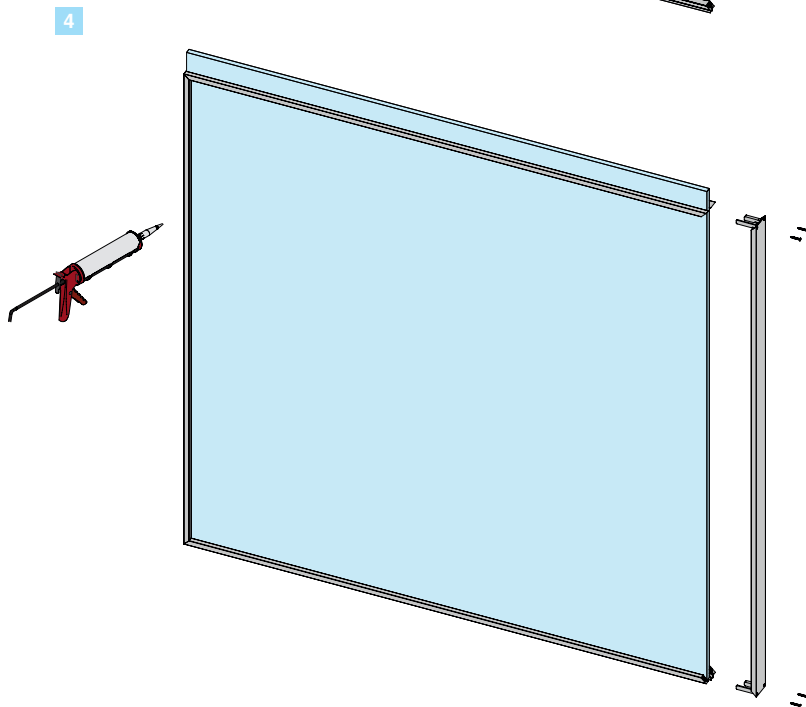
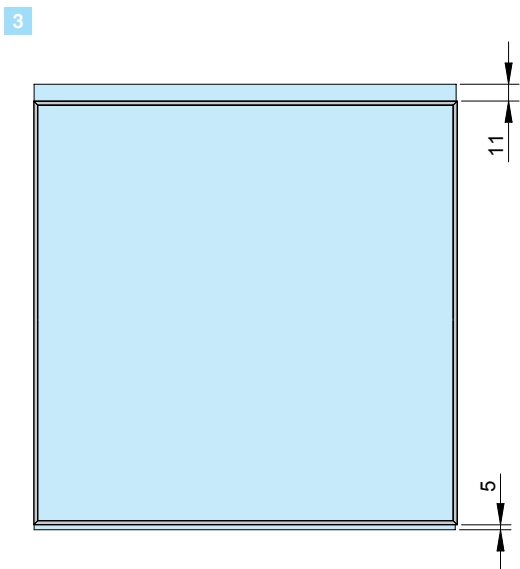
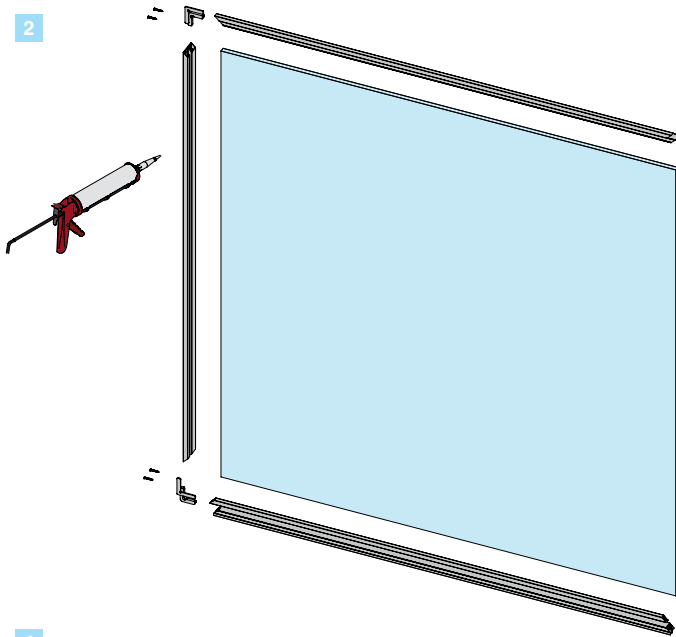
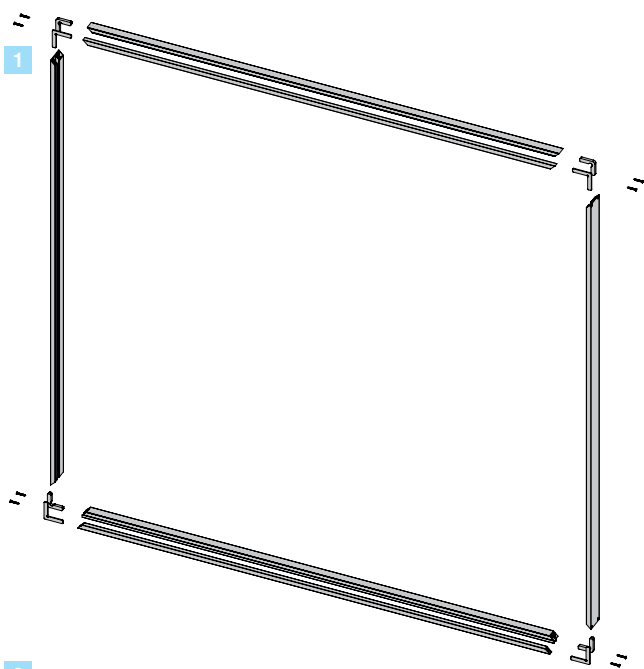



Elegancia

Elegance | Élégance

Posibilidades de instalación | Installation possibilities | Possibilités d'installation

Conjunto marco perimetral a techo | Ceiling perimeter frame set
| Kit cadre périmétral plafond

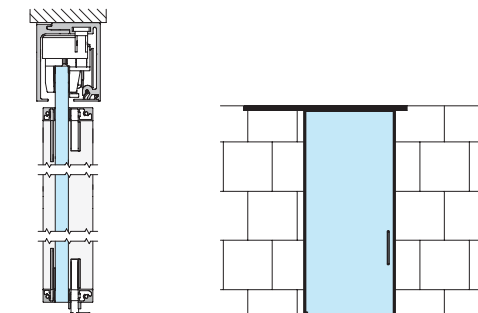

Conjunto marco perimetral a pared | Wall perimeter frame kit
| Kit cadre périmétral mur

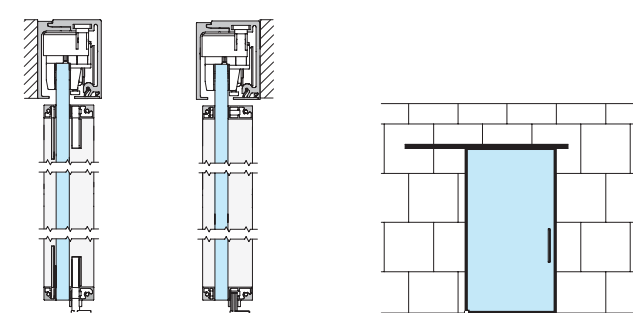

Conjunto perfil | Profile set | Jeu de profils

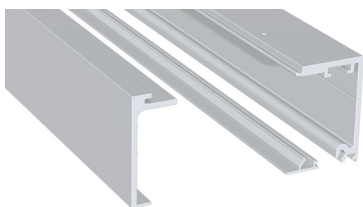

Conjunto perfil superior corredero para techo o pared
Top track set. Ceiling or wall mount
Jeu rails de roulement pour fixation à plafond ou à mur

NEW

Finished	Cod	اسطولاس	📦
S	00 70 20	2 m	1 juego 1 set 1 jeu
S	00 70 30	3 m	
S	00 70 50	5 m	
BA	00 71 24	2 m	
BA	00 71 34	3 m	
BA	00 71 54	5 m	

Juegos | Sets | Jeux



Doble Softbrake
Double softbrake
2 amortisseurs
Cod. 00 70 01



1 Softbrake + 1 anti-shock
1 Anti-shock + 1 softbrake
1 frein anti-shock +
1 amortisseur
Cod. 00 70 02



1 Softbrake +
1 freno retenedor
1 Softbrake +
1 retaining brake
1 amortisseur +
1 frein de retenue
Cod. 00 70 03



1 anti-shock + 1 anti-shock
Double Anti-shock
2 freins anti-shock
Cod. 00 70 04

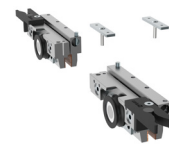

Doble freno retenedor
Double retaining brake
2 freins de retenue
Cod. 00 70 05

Opciones frame | Options frame | Options frame

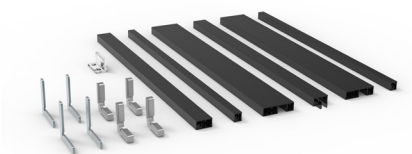

Conjunto marco perimetral
Perimeter frame set
Kit cadre périmétral

Finished	Cod	اسطولاس	📦
S	01 11 22		1 juego 1 set 1 jeu
BA	01 11 27		

Aluminio anodizado plata mate
Satin anodized aluminum
Aluminium anodisé argent



Aluminio anodizado negro
Black anodized aluminium
Aluminium anodisé noir

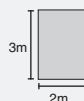

Medidas máx. de puerta
Max. Sizes of doors
Dimensions max. de porte

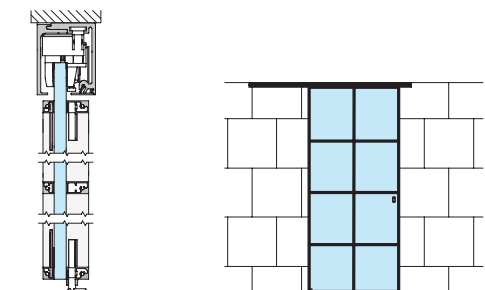
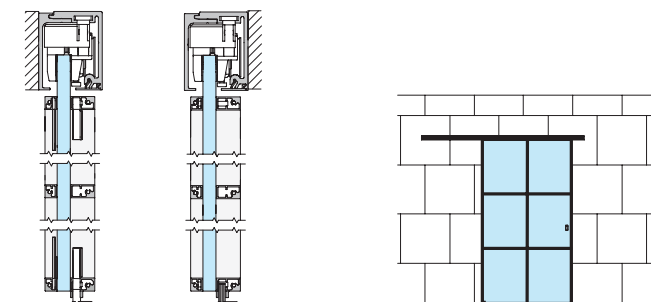
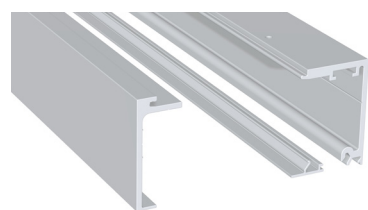
Posibilidades de instalación | Installation possibilities | Possibilités d'installation
**Conjunto división interna a techo | Ceiling internal division set
| Kit division interne plafond**

**Conjunto división interna a pared | Wall internal division set
| Kit division interne mur**

Conjunto perfil | Profile set | Jeu de profils

Conjunto perfil superior corredero para techo o pared
Top track set. Ceiling or wall mount
Jeu rails de roulement pour fixation à plafond ou à mur

NEW

Finished	Cod	اساسيات	📦
S	00 70 20	2 m	1 juego 1 set 1 jeu
S	00 70 30	3 m	
S	00 70 50	5 m	
BA	00 71 24	2 m	
BA	00 71 34	3 m	
BA	00 71 54	5 m	

Juegos | Sets | Jeux

Doble Softbrake
Double softbrake
2 amortisseurs
Cod. 00 70 01



1 Softbrake + 1 anti-shock
1 Anti-shock + 1 softbrake
1 frein anti-shock + 1 amortisseur
Cod. 00 70 02



1 Softbrake + 1 freno retenedor
1 Softbrake + 1 retaining brake
1 amortisseur + 1 frein de retenue
Cod. 00 70 03



1 anti-shock + 1 anti-shock
Double Anti-shock
2 freins anti-shock
Cod. 00 70 04

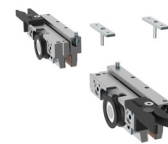

Doble freno retenedor
Double retaining brake
2 freins de retenue
Cod. 00 70 05

Opciones frame | Options frame | Options frame

Conjunto marco perimetral
Perimeter frame set
Kit cadre périmétral

Conjunto división interna
Internal division set
Kit division interne

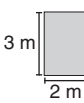
Finished	Cod	اساسيات	📦
S	01 11 22	 3 m 2 m	1 juego 1 set 1 jeu
BA	01 11 27		
S	01 11 20	3m*	1 juego 1 set 1 jeu
BA	01 11 25		

Aluminio anodizado plata mate
Satin anodized aluminum
Aluminium anodisé argent

S

Aluminio anodizado negro
Black anodized aluminum
Aluminium anodisé noir

BA

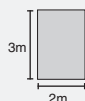

Medidas máx. de puerta
Max. Sizes of doors
Dimensions max. de porte

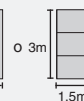
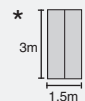

*
Añadir más kits según diseño
Add more sets according to design
Ajouter plus de kits selon design

Posibilidades de instalación | Installation possibilities | Possibilités d'installation

Conjunto marco perimetral a pared de vidrio | Glass wall perimeter frame set
| Kit cadre périmétral mur de verre

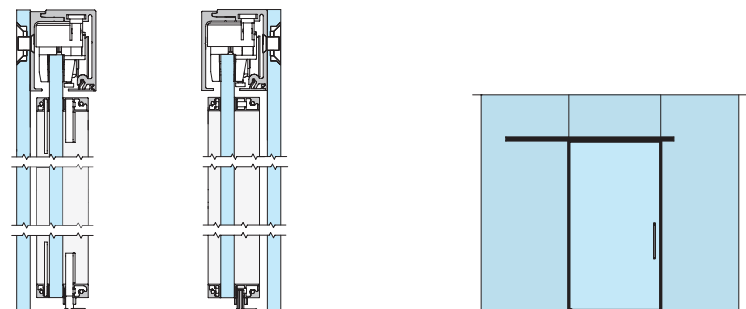

Conjunto perfil | Profile set | Jeu de profils

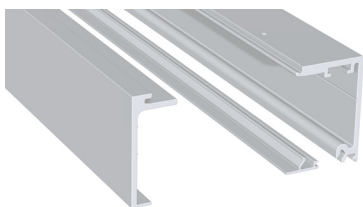

Conjunto perfil superior corredero para techo o pared
Top track set. Ceiling or wall mount
Jeu rails de roulement pour fixation à plafond ou à mur



Finished	Cod	المقياس	📦
S	00 70 20	2 m	1 juego 1 set 1 jeu
S	00 70 30	3 m	
S	00 70 50	5 m	
BA	00 71 24	2 m	
BA	00 71 34	3 m	
BA	00 71 54	5 m	

Juegos | Sets | Jeux



Doble Softbrake
Double softbrake
2 amortisseurs
Cod. 00 70 01



1 Softbrake + 1 anti-shock
1 Anti-shock + 1 softbrake
1 frein anti-shock +
1 amortisseur
Cod. 00 70 02



1 Softbrake +
1 freno retenedor
1 Softbrake +
1 retaining brake
1 amortisseur +
1 frein de retenue
Cod. 00 70 03



1 anti-shock + 1 anti-shock
Double Anti-shock
2 freins anti-shock
Cod. 00 70 04

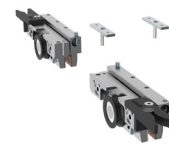

Doble freno retenedor
Double retaining brake
2 freins de retenue
Cod. 00 70 05

Opciones frame | Options frame | Options frame

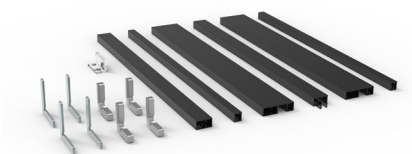

Conjunto marco perimetral
Perimeter frame set
Kit cadre périmétral

Finished	Cod	المقياس	📦
S	01 11 22		1 juego 1 set 1 jeu
BA	01 11 27		

Aluminio anodizado plata mate
Satin anodized aluminum
Aluminium anodisé argent



Aluminio anodizado negro
Black anodized aluminium
Aluminium anodisé noir

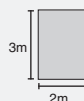

Medidas máx. de puerta
Max. Sizes of doors
Dimensions max. de porte

Posibilidades de instalación | Installation possibilities | Possibilités d'installation

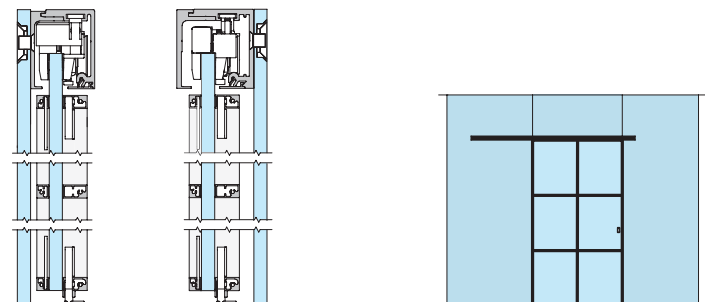
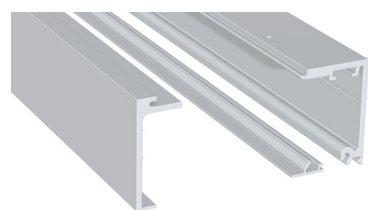
Conjunto división interna a pared de vidrio | Glass wall internal division set
 | Kit division interne mur de verre

Conjunto perfil | Profile set | Jeu de profils

Conjunto perfil superior corredero para techo o pared
 Top track set. Ceiling or wall mount
 Jeu rails de roulement pour fixation à plafond ou à mur

NEW

Finished	Cod	Medidas	Contenido
S	00 70 20	2 m	1 juego 1 set 1 jeu
S	00 70 30	3 m	
S	00 70 50	5 m	
BA	00 71 24	2 m	1 juego 1 set 1 jeu
BA	00 71 34	3 m	
BA	00 71 54	5 m	

Juegos | Sets | Jeux

Doble Softbrake
 Double softbrake
 2 amortisseurs
 Cod. 00 70 01



1 Softbrake + 1 anti-shock
 1 Anti-shock + 1 softbrake
 1 frein anti-shock + 1 amortisseur
 Cod. 00 70 02



1 Softbrake + 1 freno retenedor
 1 Softbrake + 1 retaining brake
 1 amortisseur + 1 frein de retenue
 Cod. 00 70 03



1 anti-shock + 1 anti-shock
 Double Anti-shock
 2 freins anti-shock
 Cod. 00 70 04

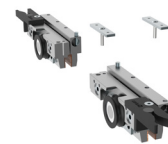

Doble freno retenedor
 Double retaining brake
 2 freins de retenue
 Cod. 00 70 05

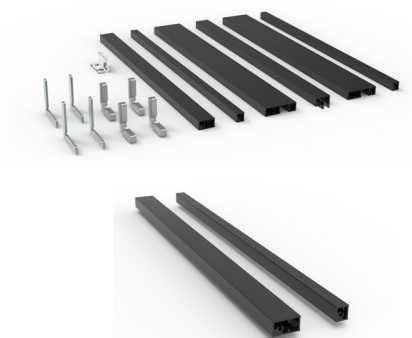
Opciones frame | Options frame | Options frame

Conjunto marco perimetral
 Perimeter frame set
 Kit cadre périmétral

Conjunto división interna
 Internal division set
 Kit division interne

Finished	Cod	Medidas	Contenido
S	01 11 22	3 m 2 m	1 juego 1 set 1 jeu
BA	01 11 27		
S	01 11 20	3m*	1 juego 1 set 1 jeu
BA	01 11 25		

Aluminio anodizado plata mate
 Satin anodized aluminium
 Aluminium anodisé argent

S

Aluminio anodizado negro
 Black anodized aluminium
 Aluminium anodisé noir

BA

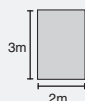

Medidas máx. de puerta
 Max. Sizes of doors
 Dimensions max. de porte

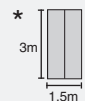

3m
 1,5m

*
 3m
 0 3m
 1,5m

Añadir más kits según diseño
 Add more sets according to design
 Ajouter plus de kits selon design

Posibilidades de instalación | Installation possibilities | Possibilités d'installation

Conjunto marco perimetral falso techo | False ceiling perimeter frame set
| Kit cadre périmétral pour faux plafond

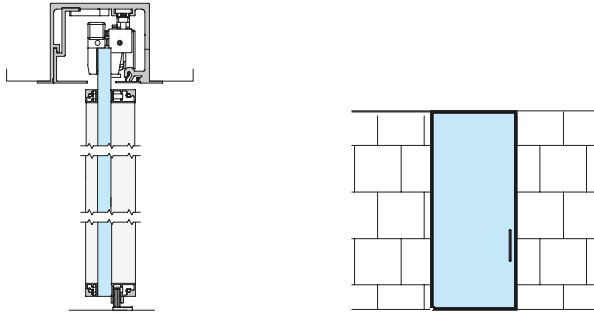

Conjunto perfil | Profile set | Jeu de profils

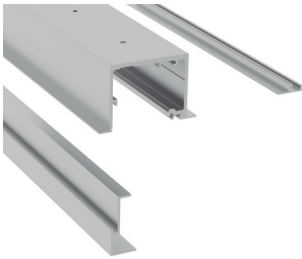

Conjunto perfil superior corredero falso techo
Top track set for false ceiling
Set Profil supérieur Glissant pour faux plafond

NEW

Finished	Cod	المقياس	📦
S	0 109 24	2 m	1 juego 1 set 1 jeu
S	0 109 34	3 m	
S	0 109 44	4 m	
S	0 109 64	6 m	
BA	0 119 26	2 m	
BA	0 119 36	3 m	
BA	0 119 46	4 m	
BA	0 119 66	6 m	

Juegos | Sets | Jeux



Doble Softbrake
Double softbrake
2 amortisseurs
Cod. 00 70 01



1 Softbrake + 1 anti-shock
1 Anti-shock + 1 softbrake
1 frein anti-shock +
1 amortisseur
Cod. 00 70 02



1 Softbrake +
1 freno retenedor
1 Softbrake +
1 retaining brake
1 amortisseur +
1 frein de retenue
Cod. 00 70 03



1 anti-shock + 1 anti-shock
Double Anti-shock
2 freins anti-shock
Cod. 00 70 04



Doble freno retenedor
Double retaining brake
2 freins de retenue
Cod. 00 70 05

Opciones frame | Options frame | Options frame

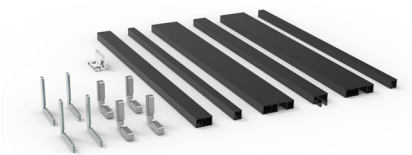

Conjunto marco perimetral
Perimeter frame set
Kit cadre périmétral

Finished	Cod	المقياس	📦
S	01 11 22		1 juego 1 set 1 jeu
BA	01 11 27		

Aluminio anodizado plata mate
Satin anodized aluminum
Aluminium anodisé argent



Aluminio anodizado negro
Black anodized aluminium
Aluminium anodisé noir

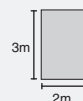

Medidas máx. de puerta
Max. Sizes of doors
Dimensions max. de porte

Posibilidades de instalación | Installation possibilities | Possibilités d'installation

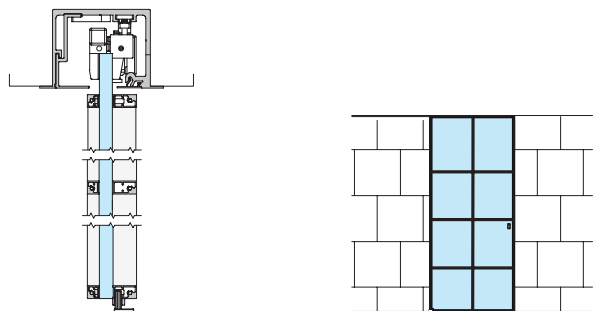
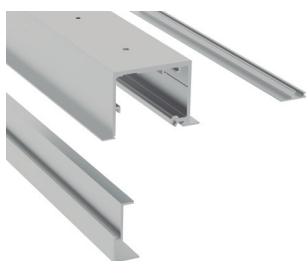
Conjunto división interna falso techo | False ceiling internal division set
 | Kit division interne pour faux plafond

Conjunto perfil | Profile set | Jeu de profils

Conjunto perfil superior corredero falso techo
 Top track set for false ceiling
 Set Profil supérieur Glissant pour faux plafond

NEW

Finished	Cod	مقياس	📦
S	0 109 24	2 m	1 juego 1 set 1 jeu
S	0 109 34	3 m	
S	0 109 44	4 m	
S	0 109 64	6 m	
BA	0 119 26	2 m	
BA	0 119 36	3 m	
BA	0 119 46	4 m	
BA	0 119 66	6 m	

Juegos | Sets | Jeux

Doble Softbrake
 Double softbrake
 2 amortisseurs
 Cod. 00 70 01



1 Softbrake + 1 anti-shock
 1 Anti-shock + 1 softbrake
 1 frein anti-shock +
 1 amortisseur
 Cod. 00 70 02



1 Softbrake + 1 freno retenedor
 1 Softbrake +
 1 retaining brake
 1 amortisseur +
 1 frein de retenue
 Cod. 00 70 03



1 anti-shock +
 1 anti-shock
 Double Anti-shock
 2 freins anti-shock
 Cod. 00 70 04

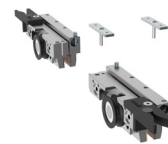

Doble freno retenedor
 Double retaining brake
 2 freins de retenue
 Cod. 00 70 05

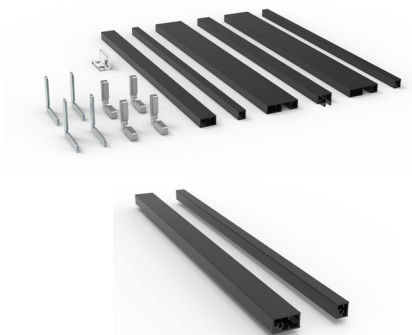
Opciones frame | Options frame | Options frame

Conjunto marco perimetral
 Perimeter frame set
 Kit cadre périmétral

Conjunto división interna
 Internal division set
 Kit division interne

Finished	Cod	مقياس	📦
S	01 11 22	3 m 2 m	1 juego 1 set 1 jeu
BA	01 11 27		
S	01 11 20	3m*	1 juego 1 set 1 jeu
BA	01 11 25		

Aluminio anodizado plata mate
 Satin anodized aluminium
 Aluminium anodisé argent

S

Aluminio anodizado negro
 Black anodized aluminium
 Aluminium anodisé noir

BA

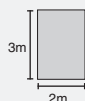

Medidas máx. de puerta
 Max. Sizes of doors
 Dimensions max. de porte

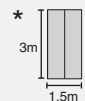

Añadir más kits según diseño
 Add more sets according to design
 Ajouter plus de kits selon design

Posibilidades de instalación | Installation possibilities | Possibilités d'installation

Conjunto marco perimetral falso techo vidrio fijo | False ceiling with fixed glass
perimeter frame set | Kit cadre périmétral pour faux plafond avec verre fixe

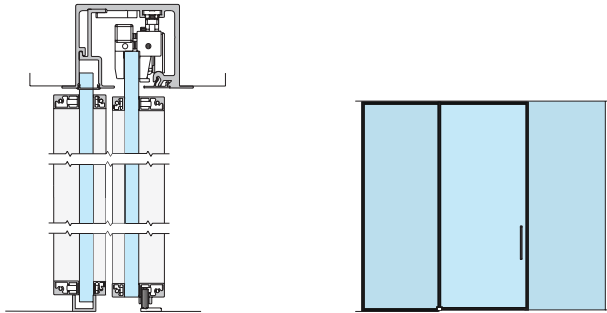

Conjunto perfil | Profile set | Jeu de profils

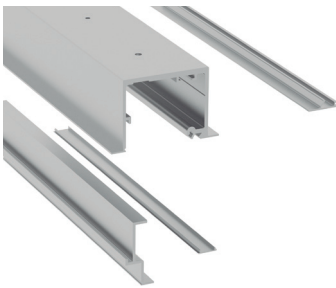

Conjunto perfil superior corredero
falso techo vidrio fijo
Top track set for false ceiling + Fixed
Glass
Set profil supérieur glissant pour faux
plafond verre fixe



Finished	Cod	Length	Icon
S	0 109 26	2 m	1 juego 1 set 1 jeu
S	0 109 36	3 m	
S	0 109 46	4 m	
S	0 109 66	6 m	
BA	0 119 27	2 m	
BA	0 119 37	3 m	
BA	0 119 47	4 m	
BA	0 119 67	6 m	

Juegos | Sets | Jeux

<p>Doble Sotbrake Double softbrake 2 amortisseurs Cod. 00 70 01</p>	<p>1 Sotbrake + 1 anti-shock 1 Anti-shock + 1 soft-brake 1 frein anti-shock + 1 amortisseur Cod. 00 70 02</p>	<p>1 Softbrake + 1 freno retenedor 1 Softbrake + 1 retaining brake 1 amortisseur + 1 frein de retenue Cod. 00 70 03</p>	<p>1 anti-shock + 1 anti-shock Double Anti-shock 2 freins anti-shock Cod. 00 70 04</p>	<p>Doble freno retenedor Double retaining brake 2 freins de retenue Cod. 00 70 05</p>
---	---	---	--	---

Opciones frame | Options frame | Options frame



Conjunto marco perimetral
Perimeter frame set
Kit cadre périmétral

Conjunto marco perimetral vidrio fijo falso techo
Perimeter frame for fixed glass and false ceiling kit
Kit de cadre périmétral verre fixe et faux plafond

Finished	Cod	Dimensions	Icon
S	01 11 22		1 juego 1 set 1 jeu
BA	01 11 27		
S	01 11 28		1 juego 1 set 1 jeu
BA	01 11 29		

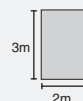

Posibilidades de instalación | Installation possibilities | Possibilités d'installation

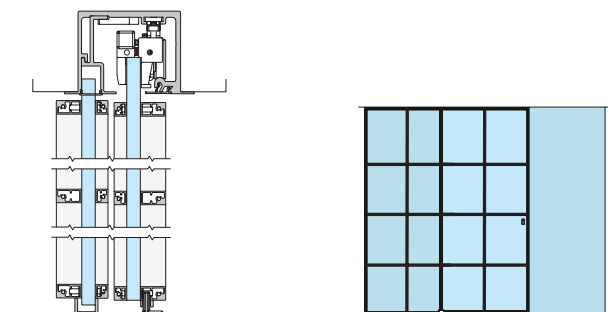
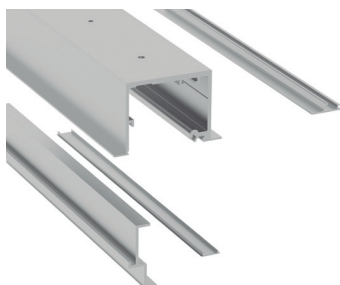
Conjunto división interna falso techo vidrio fijo | False ceiling with fixed glass
 internal division set | Kit division interne pour faux plafond avec verre fixe

Conjunto perfil | Profile set | Jeu de profils

Conjunto perfil superior corredero
 falso techo vidrio fijo
 Top track set for false ceiling + Fixed
 Glass
 Set profil supérieur glissant pour faux
 plafond verre fixe

NEW

Finished	Cod	Measure	Icon
S	0 109 26	2 m	1 juego 1 set 1 jeu
S	0 109 36	3 m	
S	0 109 46	4 m	
S	0 109 66	6 m	
BA	0 119 27	2 m	
BA	0 119 37	3 m	
BA	0 119 47	4 m	
BA	0 119 67	6 m	

Juegos | Sets | Jeux

Doble Sotbrake
 Double softbrake
 2 amortisieurs
 Cod. 00 70 01



1 Sotbrake + 1 anti-shock
 1 Anti-shock + 1 softbrake
 1 frein anti-shock +
 1 amortisseur
 Cod. 00 70 02



1 Softbrake + 1 freno
 retenedor
 1 Softbrake +
 1 retaining brake
 1 amortisseur +
 1 frein de retenue
 Cod. 00 70 03



1 anti-shock +
 1 anti-shock
 Double Anti-shock
 2 freins anti-shock
 Cod. 00 70 04



Doble freno retenedor
 Double retaining brake
 2 freins de retenue
 Cod. 00 70 05

Opciones frame | Options frame | Options frame

Conjunto marco perimetral
 Perimeter frame set
 Kit cadre périmétral

Conjunto división interna
 Internal division set
 Kit division interne

Conjunto marco perimetral vidrio
 fijo falso techo
 Perimeter frame for fixed glass
 and false ceiling kit
 Kit de cadre périmétral verre fixe
 et faux plafond

Finished	Cod	Measure	Icon
S	01 11 22	3 m 2 m	1 juego 1 set 1 jeu
BA	01 11 27		
S	01 11 20	3m*	1 juego 1 set 1 jeu
BA	01 11 25		
S	01 11 28	3m 2m	1 juego 1 set 1 jeu
BA	01 11 29		

Aluminio anodizado plata mate
 Satin anodized aluminium
 Aluminium anodisé argent

S

Aluminio anodizado negro
 Black anodized aluminium
 Aluminium anodisé noir

BA

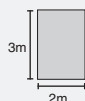

Medidas máx. de puerta
 Max. Sizes of doors
 Dimensions max. de porte

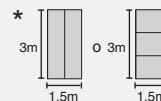

*
 Añadir más kits según diseño
 Add more sets according to design
 Ajouter plus de kits selon design



**FRAME
SV-X110**



Pictogramas | Pictograms | Pictogrammes

Perfilería | Profiles | Profils

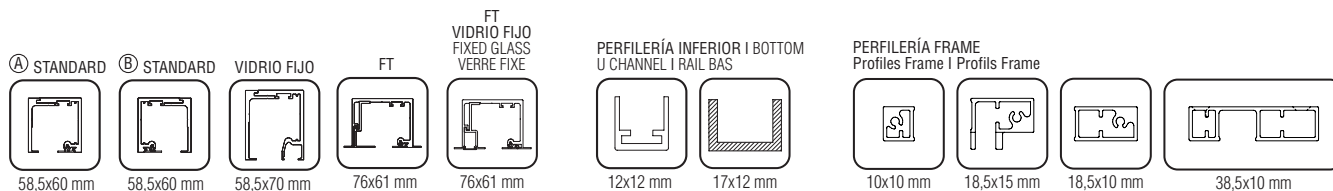

Especificaciones | Specifications | Spécifications

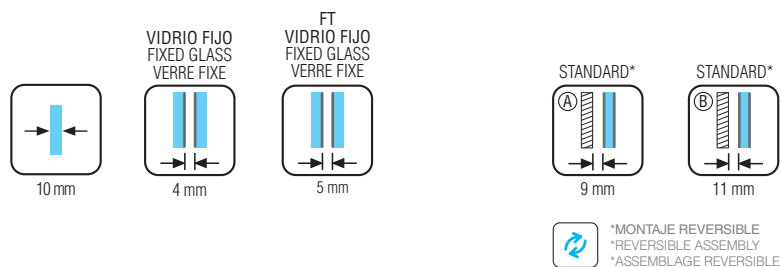

Peso | Weights | Poids

110 kg

242 lb

Variantes de instalación | Installation possibilities | Variantes d'installation



Variantes de instalación | Installation possibilities | Variantes d'installation

1 OPCIÓN PUERTA CORREDERA A TECHO | SLIDING DOOR FOR CEILING | PORTE COULISSANTE POUR PLAFOND

Conjunto marco perimetral a techo
 Ceiling perimeter frame set
 Kit cadre périmétral plafond

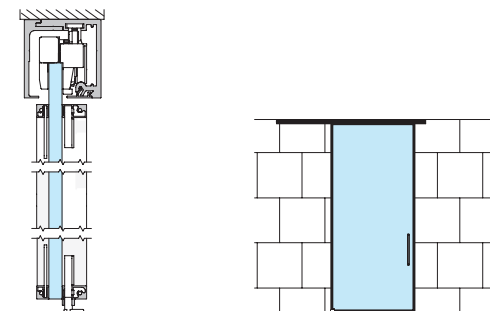

Conjunto división interna a techo
 Ceiling internal division set
 Kit division interne plafond

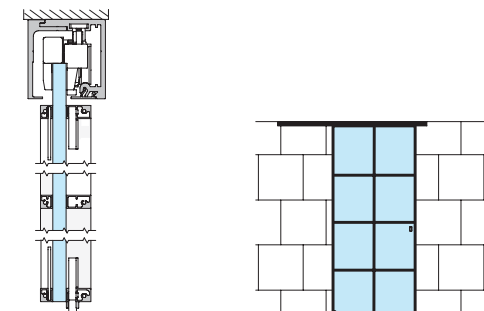

2 OPCIÓN PUERTA CORREDERA A PARED | SLIDING DOOR FOR WALL | PORTE COULISSANTE POUR MUR

Conjunto marco perimetral a pared
 Wall perimeter frame kit
 Kit cadre périmétral mur

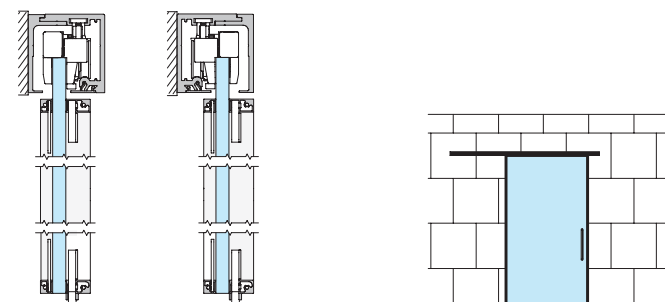

Conjunto división interna a pared
 Wall internal division set
 Kit division interne mur

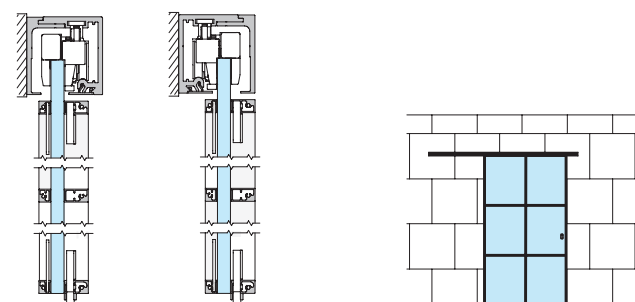

3 OPCIÓN PUERTA CORREDERA A PARED DE VIDRIO | SLIDING DOOR FOR GLASS WALL |
 | PORTE COULISSANTE POUR MUR DE VERRE

Conjunto marco perimetral a pared de vidrio
 Glass wall perimeter frame set
 Kit cadre périmétral mur de verre

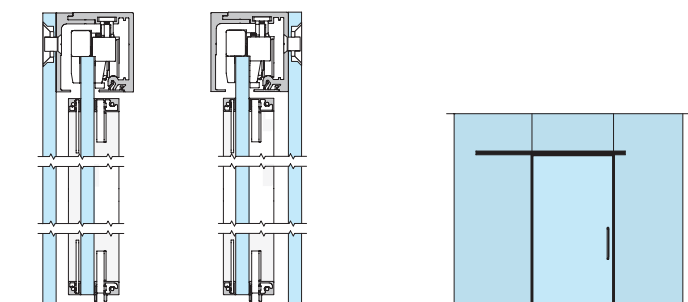

Conjunto división interna a pared de vidrio
 Glass wall internal division set
 Kit division interne mur de verre

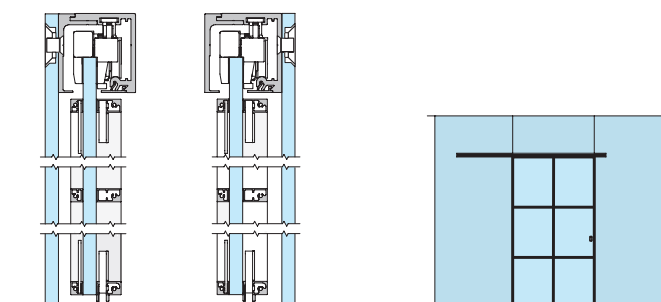

4 OPCIÓN VIDRIO FIJO A TECHO | CEILING FIXED GLASS | VERRE FIXE POUR PLAFOND

Conjunto marco perimetral a techo
Ceiling perimeter frame set
Kit cadre périmétral plafond

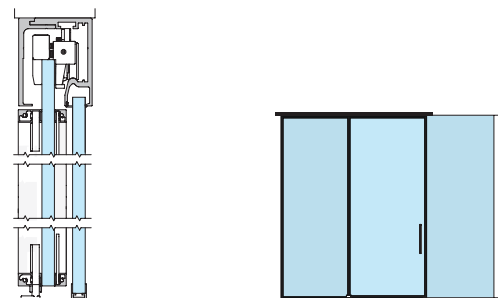

5 OPCIÓN PUERTA CORREDERA A FALSO TECHO | SLIDING DOOR FOR FALSE CEILING | PORTE COULISSANTE POUR FAUX PLAFOND

Conjunto marco perimetral falso techo
False ceiling perimeter frame set
Kit cadre périmétral pour faux plafond

Conjunto división interna falso techo
False ceiling internal division set
Kit division interne pour faux plafond

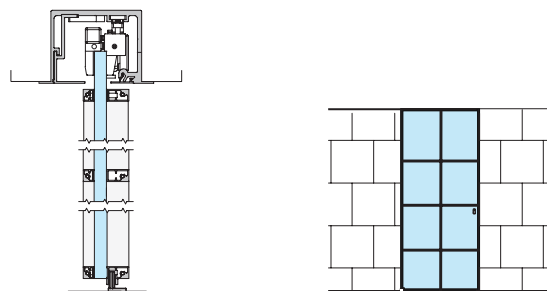
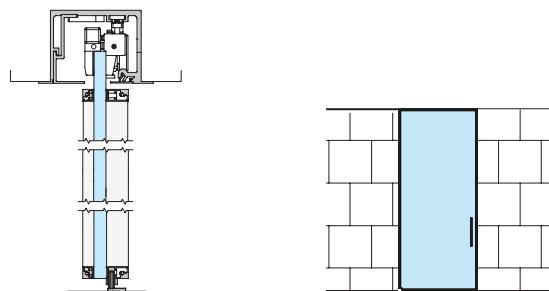

6 OPCIÓN VIDRIO FIJO A FALSO TECHO | FIXED GLASS FOR FALSE CEILING | VERRE FIXE ET FAUX PLAFOND

Conjunto marco perimetral falso techo vidrio fijo
False ceiling with fixed glass perimeter frame set
Kit cadre périmétral pour faux plafond avec verre fixe

Conjunto división interna falso techo vidrio fijo
False ceiling with fixed glass internal division set
Kit division interne pour faux plafond avec verre fixe

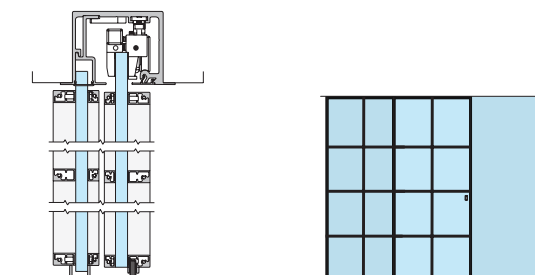
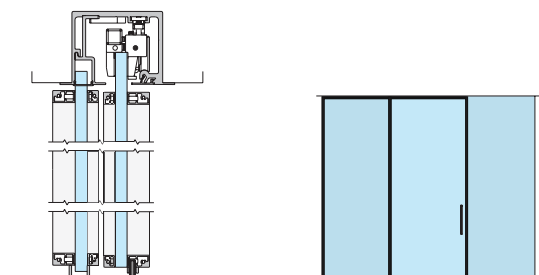

Montaje a pared | Wall mount | Fixation à mur

(Cotas en mm / Dimensions in mm / Dimensions en mm)

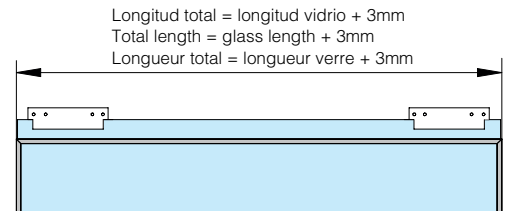
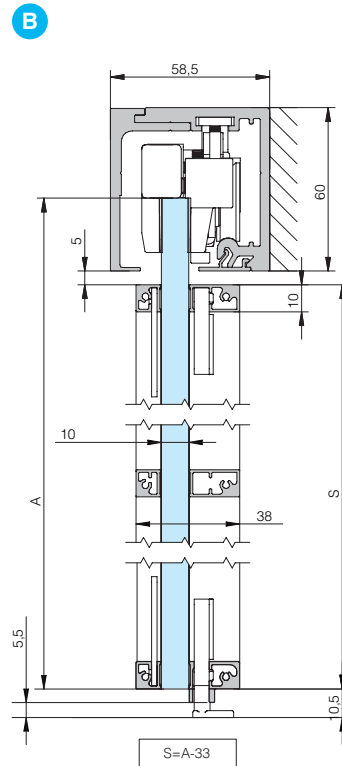
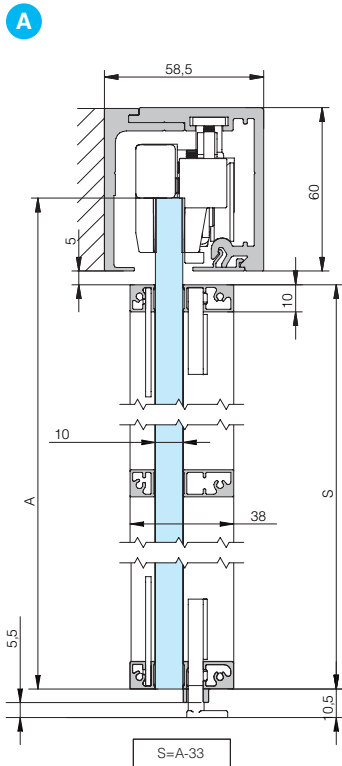

Montaje a techo | Ceiling mount | Fixation a plafond

(Cotas en mm / Dimensions in mm / Dimensions en mm)

OPCIÓN VIDRIO FIJO | FIXED GLASS OPTION | OPTION VERRE FIXE

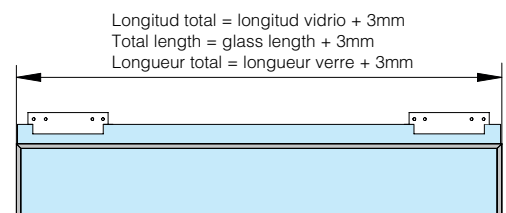
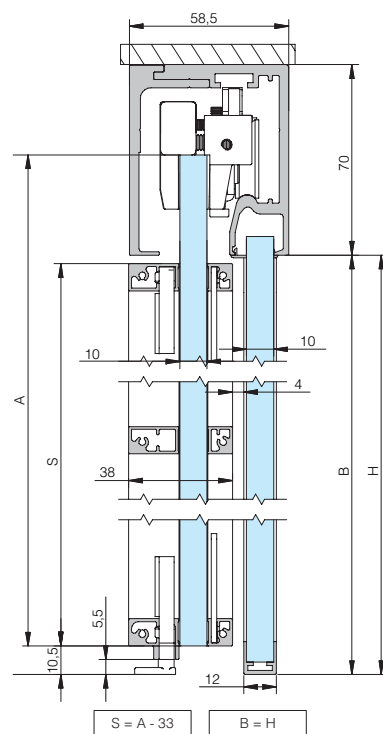
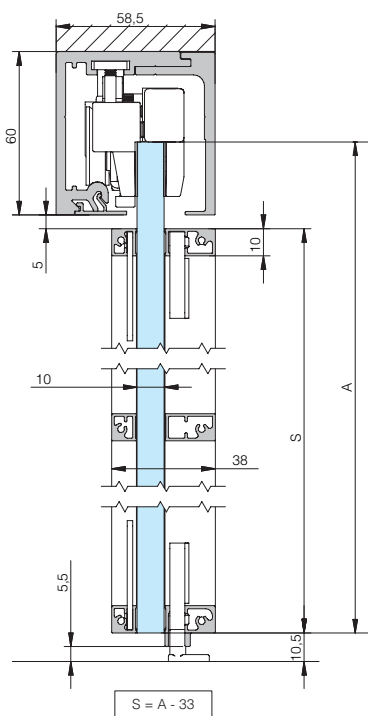

Montaje a pared de vidrio | Glass wall mount | Fixation sur verre

(Cotas en mm / Dimensions in mm / Dimensions en mm)

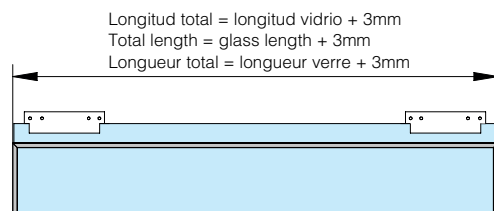
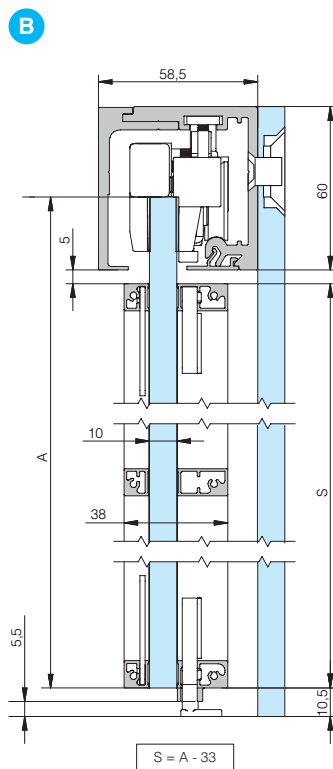
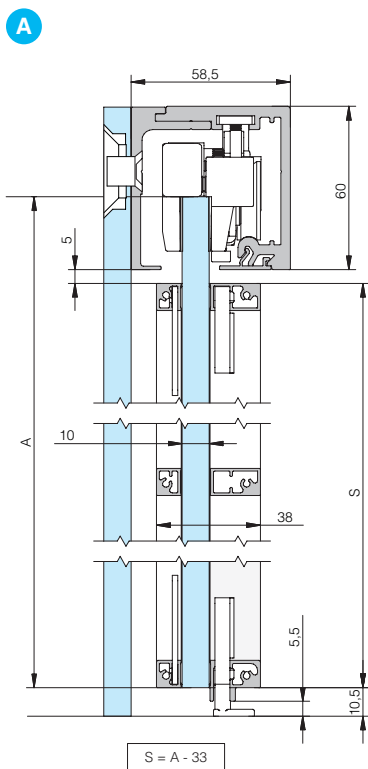
Montaje a falso techo | False ceiling filling | Montage sur faux-plafond

(Cotas en mm / Dimensions in mm / Dimensions en mm)

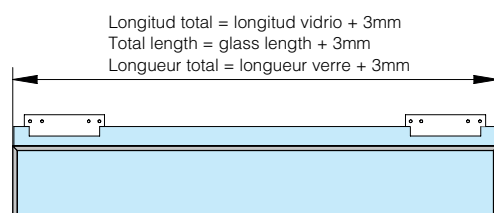
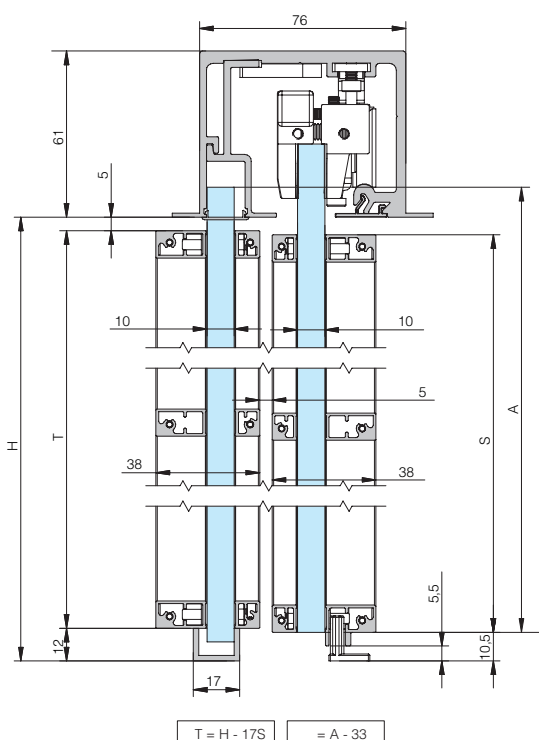
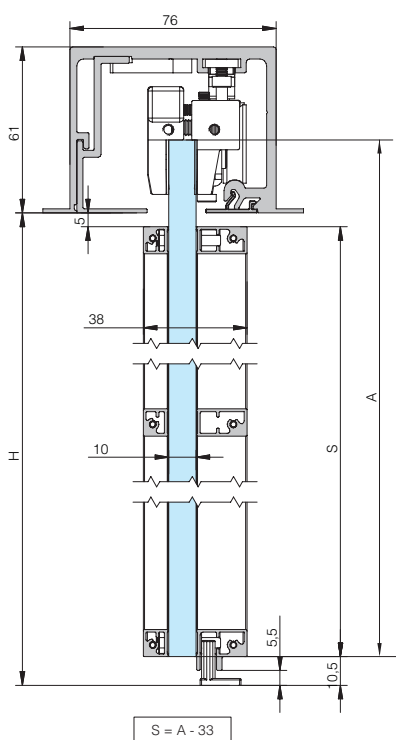
OPCIÓN VIDRIO FIJO | FIXED GLASS OPTION | OPTION VERRE FIXE

Puerta corredera a techo y a pared | Sliding door for ceiling and wall | Porte coulissante pour plafond et mur

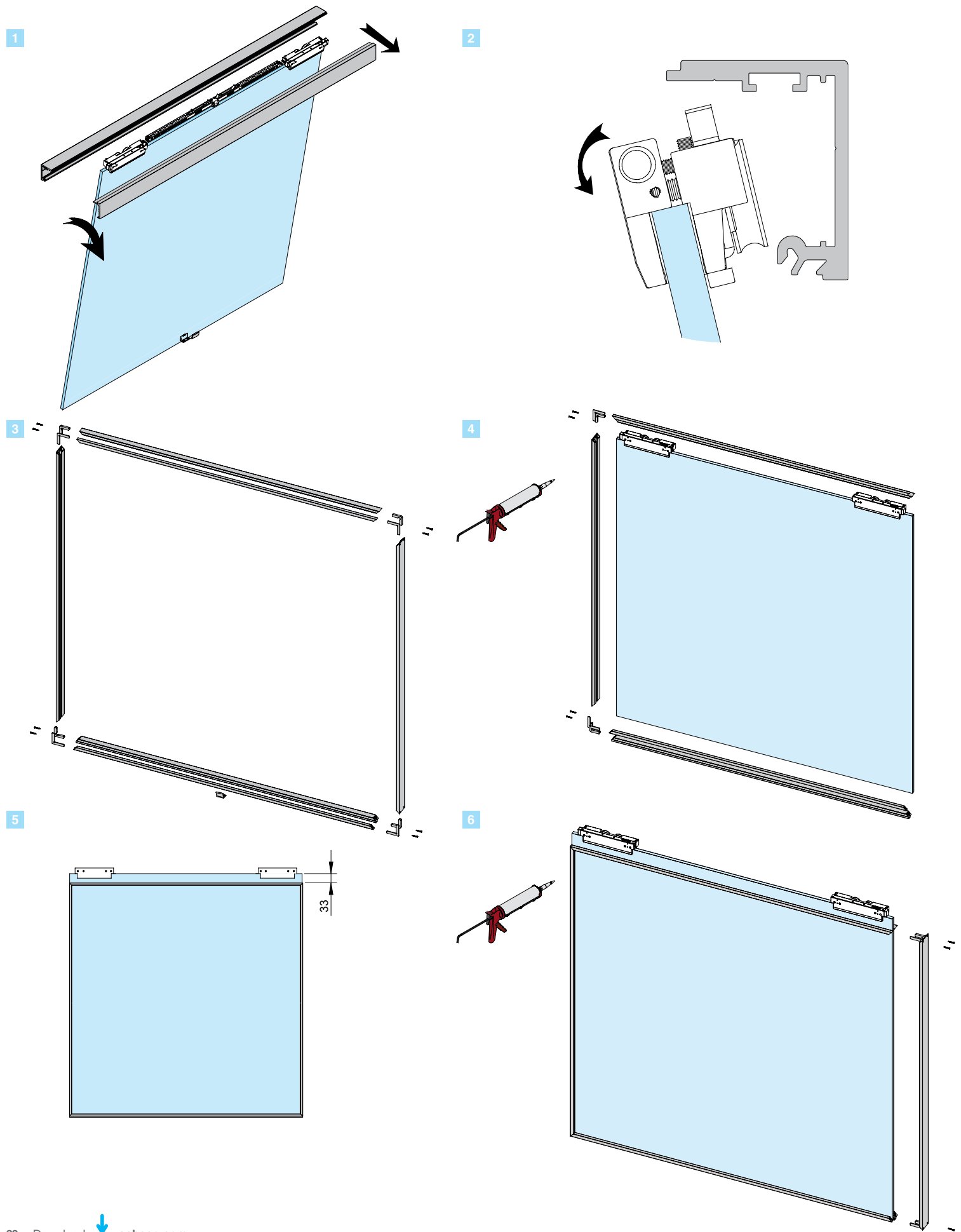

Falso techo vidrio fijo | False ceiling fixed glass | Faux plafond verre fixe

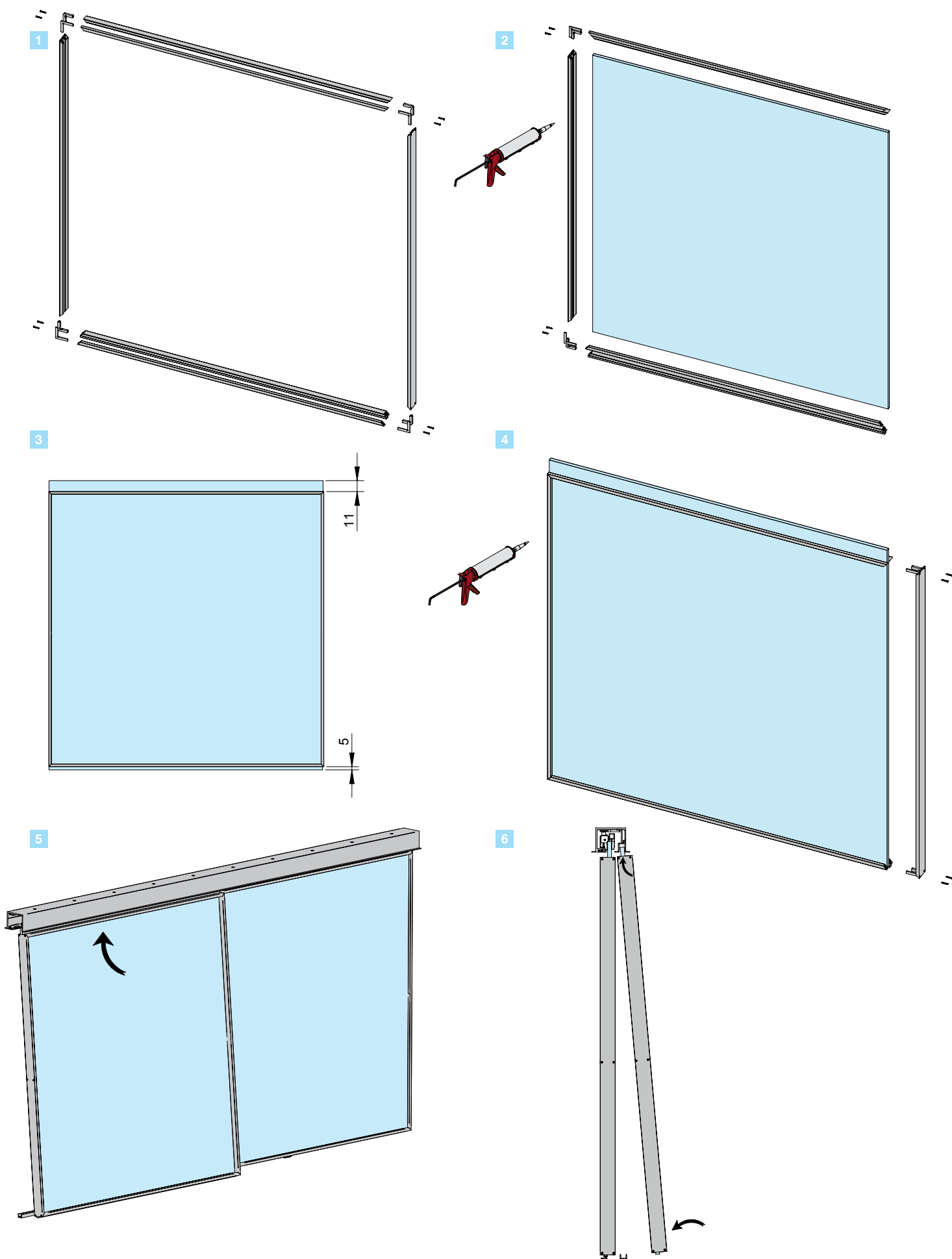

Vidrio fijo | Fixed glass | Verre fixe

1

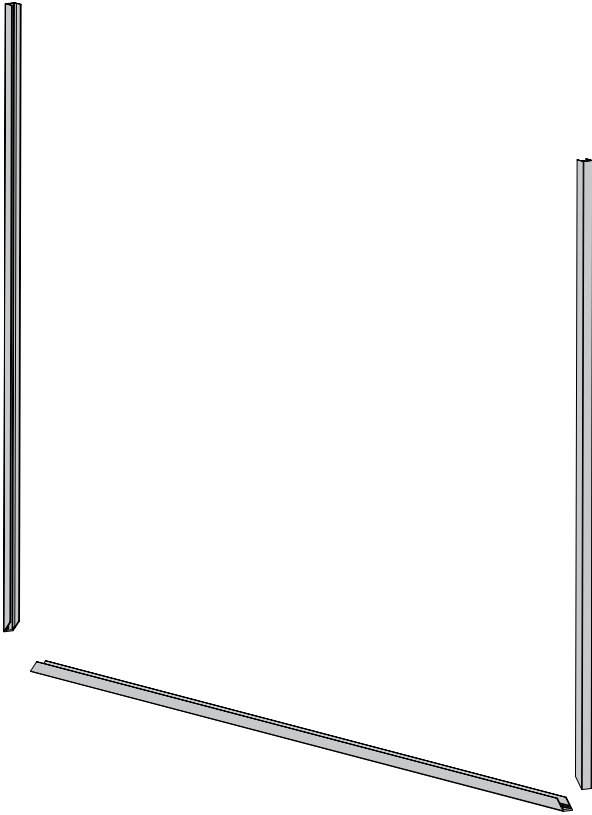

2

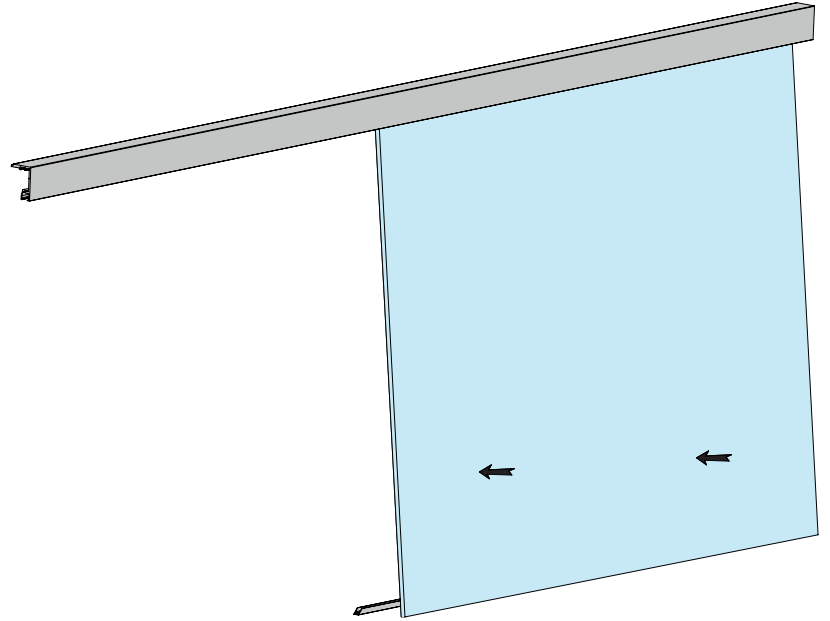

3

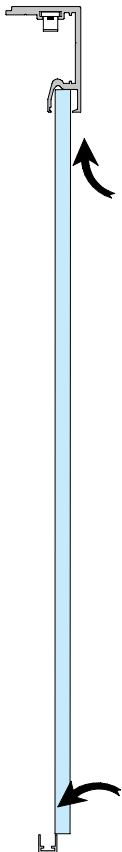

4

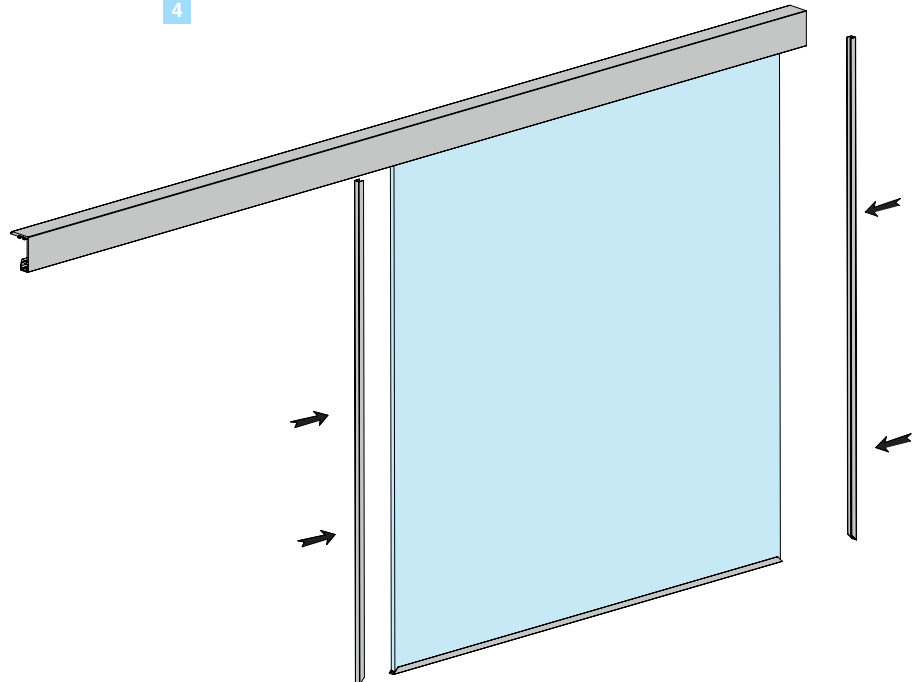

División interna | Internal division | Division interne

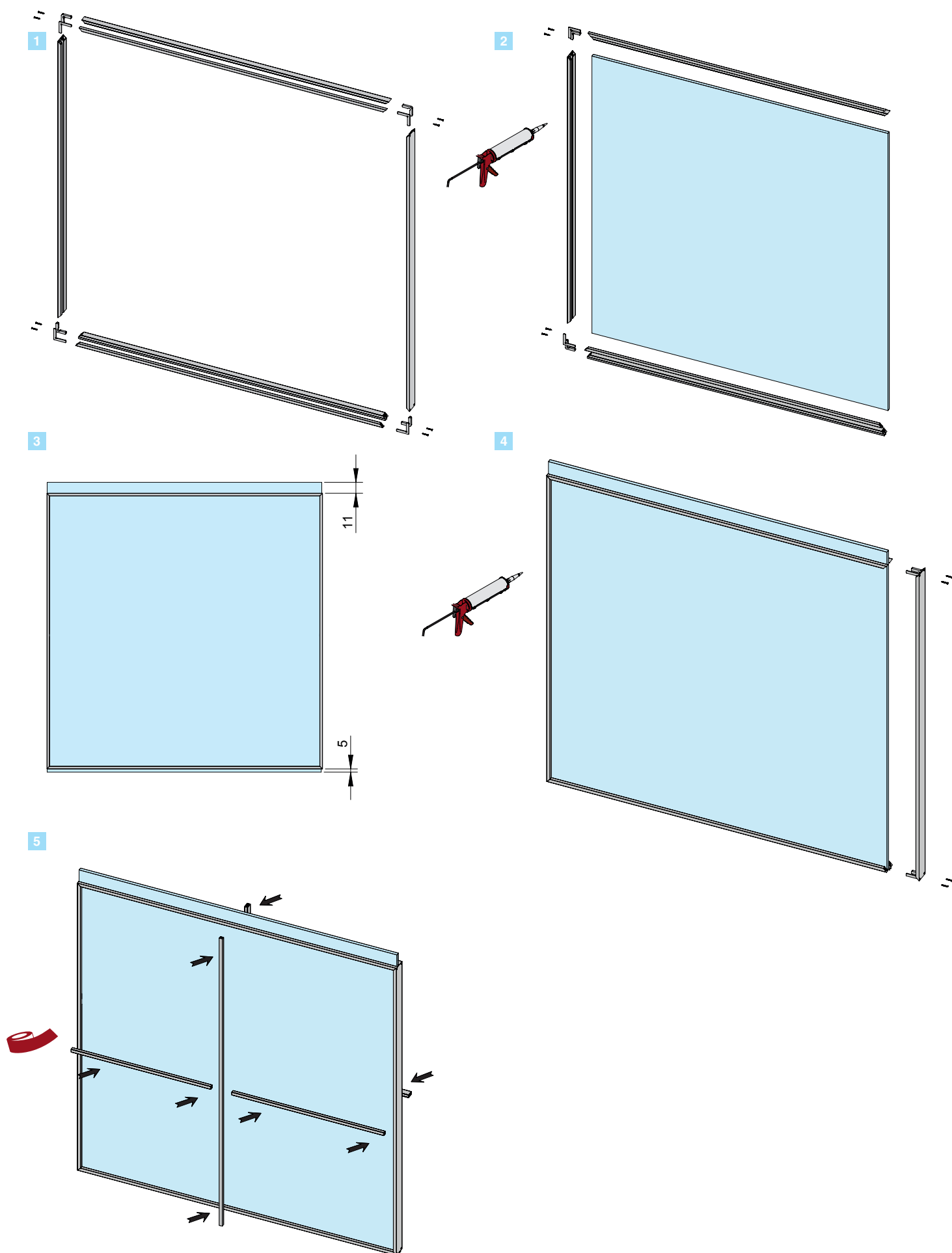

Posibilidades de instalación | Installation possibilities | Possibilités d'installation

Conjunto marco perimetral a techo | Ceiling perimeter frame set
| Kit cadre périmétral plafond

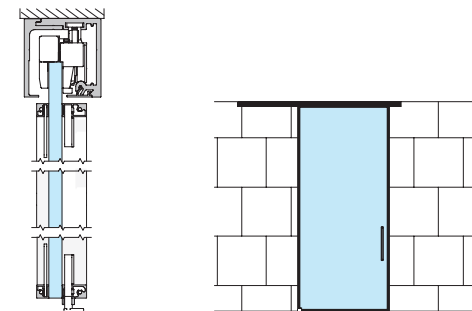

Conjunto marco perimetral a pared | Wall perimeter frame kit
| Kit division interne mur

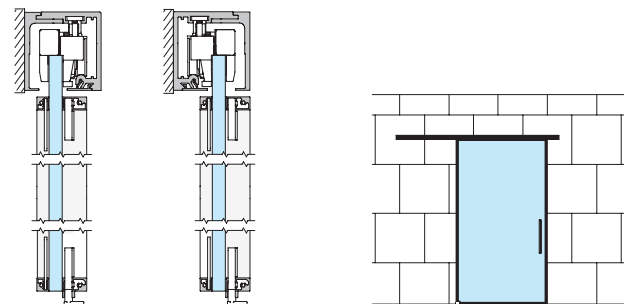

Conjunto perfil | Profile set | Jeu de profils

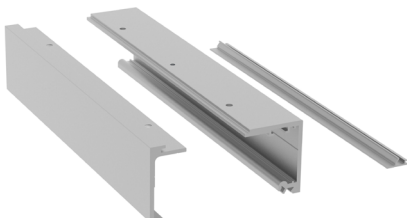

Conjunto perfil superior corredero para techo o pared
Top track set. Ceiling or wall mount
Jeu rails de roulement pour fixation à plafond ou à mur



Finished	Cod	المساحة	📦
S	0 109 20	2 m	1 juego 1 set 1 jeu
S	0 109 30	3 m	
S	0 109 40	4 m	
S	0 109 60	6 m	
BA	0 119 24	2 m	
BA	0 119 34	3 m	
BA	0 119 44	4 m	
BA	0 119 64	6 m	

Juegos | Sets | Jeux



Doble Freno retenedor
Double retaining break
2 freins de retenue

Cod. 0 109 00



Doble Anti-shock
Double Anti-shock
2 Anti-shock

Cod. 0 109 01



SOFTPRO doble
Double SOFTPRO
SOFTPRO double

Cod. 0 109 02



Freno retenedor + SOFTPRO simple
Retainig break + simple SOFTPRO
Frein de retenue + SOFTPRO simple

Cod. 0 109 03



Freno retenedor + Anti-shock
Retainig break + Anti-shock
Frein de retenue + Anti-shock

Cod. 0 109 04



Anti-shock + SOFTPRO simple
Anti-shock + simple SOFTPRO
Anti-shock + SOFTPRO simple

Cod. 0 109 05

Opciones frame | Options frame | Options frame

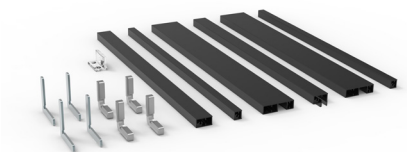

Conjunto marco perimetral
Perimeter frame set
Kit cadre périmétral

Finished	Cod	المساحة	📦
S	01 11 22		1 juego 1 set 1 jeu
BA	01 11 27		

Aluminio anodizado plata mate
Satin anodized aluminum
Aluminium anodisé argent



Aluminio anodizado negro
Black anodized aluminium
Aluminium anodisé noir

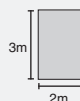

Medidas máx. de puerta
Max. Sizes of doors
Dimensions max. de porte

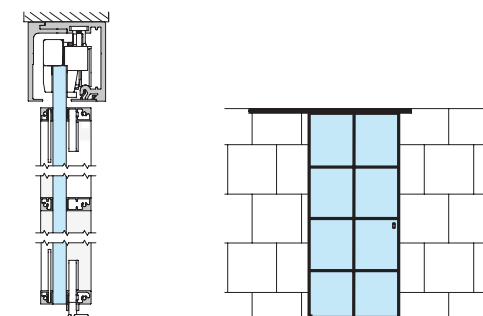
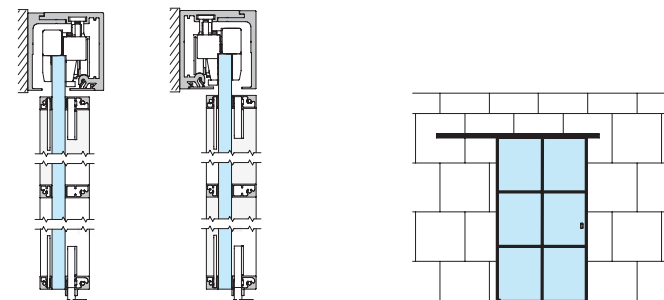
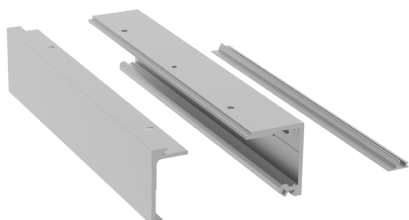
Posibilidades de instalación | Installation possibilities | Possibilités d'installation
Conjunto división interna a techo | Ceiling internal division set
 | Kit division interne plafond

Conjunto división interna a pared | Wall internal division set
 | Kit division interne mur

Conjunto perfil | Profile set | Jeu de profils

Conjunto perfil superior corredero para techo o pared
 Top track set. Ceiling or wall mount
 Jeu rails de roulement pour fixation à plafond ou à mur



Finished	Cod	مقياس	📦
S	0 109 20	2 m	1 juego 1 set 1 jeu
S	0 109 30	3 m	
S	0 109 40	4 m	
S	0 109 60	6 m	
BA	0 119 24	2 m	
BA	0 119 34	3 m	
BA	0 119 44	4 m	
BA	0 119 64	6 m	

Juegos | Sets | Jeux

Doble Freno retenedor
 Double retaining break
 2 freins de retenue
 Cod. 0 109 00



Doble Anti-shock
 Double Anti-shock
 2 Anti-shock
 Cod. 0 109 01



SOFTPRO doble
 Double SOFTPRO
 SOFTPRO double
 Cod. 0 109 02



Freno retenedor + SOFTPRO simple
 Retainig break + simple SOFTPRO
 Frein de retenue + SOFTPRO simple
 Cod. 0 109 03



Freno retenedor + Anti-shock
 Retainig break + Anti-shock
 Frein de retenue + Anti-shock
 Cod. 0 109 04



Anti-shock + SOFTPRO simple
 Anti-shock + simple SOFTPRO
 Anti-shock + SOFTPRO simple
 Cod. 0 109 05

Opciones frame | Options frame | Options frame

Conjunto marco perimetral
 Perimeter frame set
 Kit cadre périmétral

Conjunto división interna
 Internal division set
 Kit division interne

Finished	Cod	مقياس	📦
S	01 11 22	3 m 	1 juego 1 set 1 jeu
BA	01 11 27		
S	01 11 20	3m*	1 juego 1 set 1 jeu
BA	01 11 25		

Aluminio anodizado plata mate
 Satin anodized aluminum
 Aluminium anodisé argent



Aluminio anodizado negro
 Black anodized aluminium
 Aluminium anodisé noir

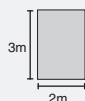

Medidas máx. de puerta
 Max. Sizes of doors
 Dimensions max. de porte

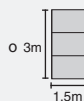
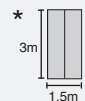

Añadir más kits según diseño
 Add more sets according to design
 Ajouter plus de kits selon design

Posibilidades de instalación | Installation possibilities | Possibilités d'installation

Conjunto marco perimetral a pared de vidrio | Glass wall perimeter frame set
| Kit cadre périmétral mur de verre

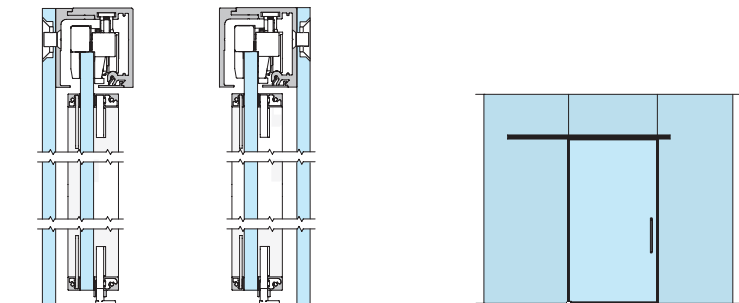

Conjunto perfil | Profile set | Jeu de profils

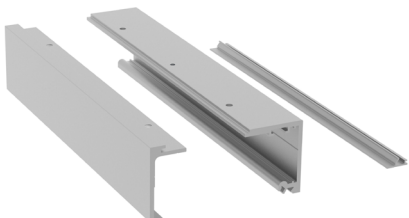

Conjunto perfil superior corredero para techo o pared
Top track set. Ceiling or wall mount
Jeu rails de roulement pour fixation à plafond ou à mur

NEW

Finished	Cod	Medidas máx. de puerta	Max. Sizes of doors	Dimensions max. de porte
S	0 109 20	2 m	1 juego 1 set 1 jeu	
S	0 109 30	3 m		
S	0 109 40	4 m		
S	0 109 60	6 m		
BA	0 119 24	2 m		
BA	0 119 34	3 m		
BA	0 119 44	4 m		
BA	0 119 64	6 m		

Juegos | Sets | Jeux



Doble Freno retenedor
Double retaining break
2 freins de retenue
Cod. 0 109 00



Doble Anti-shock
Double Anti-shock
2 Anti-shock
Cod. 0 109 01



SOFTPRO doble
Double SOFTPRO
SOFTPRO double
Cod. 0 109 02



Freno retenedor + SOFTPRO simple
Retainig break + simple SOFTPRO
Frein de retenue + SOFTPRO simple
Cod. 0 109 03



Freno retenedor + Anti-shock
Retainig break + Anti-shock
Frein de retenue + Anti-shock
Cod. 0 109 04



Anti-shock + SOFTPRO simple
Anti-shock + simple SOFTPRO
Anti-shock + SOFTPRO simple
Cod. 0 109 05

Opciones frame | Options frame | Options frame

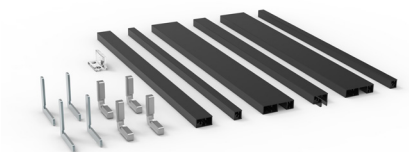

Conjunto marco perimetral
Perimeter frame set
Kit cadre périmétral

Finished	Cod	Medidas máx. de puerta	Max. Sizes of doors	Dimensions max. de porte
S	01 11 22	3 m 2 m	1 juego 1 set 1 jeu	
BA	01 11 27			

Aluminio anodizado plata mate
Satin anodized aluminum
Aluminium anodisé argent



Aluminio anodizado negro
Black anodized aluminium
Aluminium anodisé noir

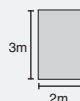

Medidas máx. de puerta
Max. Sizes of doors
Dimensions max. de porte

Posibilidades de instalación | Installation possibilities | Possibilités d'installation

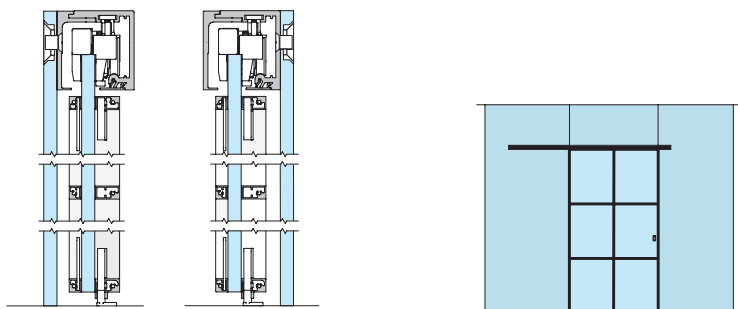
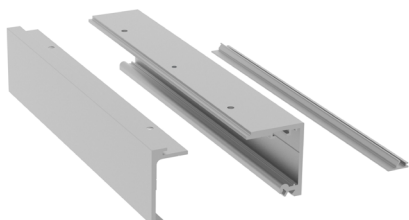
Conjunto división interna a pared de vidrio | Glass wall internal division set
 | Kit division interne mur de verre

Conjunto perfil | Profile set | Jeu de profils

Conjunto perfil superior corredero para techo o pared
 Top track set. Ceiling or wall mount
 Jeu rails de roulement pour fixation à plafond ou à mur

Finished	Cod	مقياس	📦
S	0 109 20	2 m	1 juego 1 set 1 jeu
S	0 109 30	3 m	
S	0 109 40	4 m	
S	0 109 60	6 m	
BA	0 119 24	2 m	
BA	0 119 34	3 m	
BA	0 119 44	4 m	
BA	0 119 64	6 m	

Juegos | Sets | Jeux

Doble Freno retenedor
 Double retaining break
 2 freins de retenue
 Cod. 0 109 00



Doble Anti-shock
 Double Anti-shock
 2 Anti-shock
 Cod. 0 109 01



SOFTPRO doble
 Double SOFTPRO
 SOFTPRO double
 Cod. 0 109 02



Freno retenedor + SOFTPRO simple
 Retainig break + simple SOFTPRO
 Frein de retenue + SOFTPRO simple
 Cod. 0 109 03



Freno retenedor + Anti-shock
 Retainig break + Anti-shock
 Frein de retenue + Anti-shock
 Cod. 0 109 04

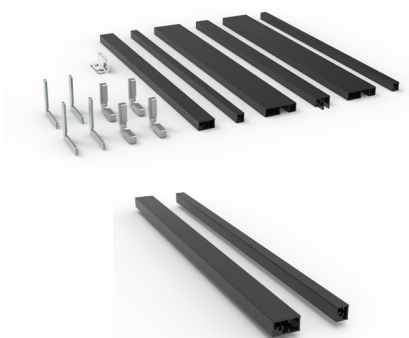

Anti-shock + SOFTPRO simple
 Anti-shock + simple SOFTPRO
 Anti-shock + SOFTPRO simple
 Cod. 0 109 05

Opciones frame | Options frame | Options frame

Conjunto marco perimetral
 Perimeter frame set
 Kit cadre périmétral

Conjunto división interna
 Internal division set
 Kit division interne

Finished	Cod	مقياس	📦
S	01 11 22	3 m 2 m	1 juego 1 set 1 jeu
BA	01 11 27		
S	01 11 20	3m*	1 juego 1 set 1 jeu
BA	01 11 25		

Aluminio anodizado plata mate
 Satin anodized aluminum
 Aluminium anodisé argent

Aluminio anodizado negro
 Black anodized aluminum
 Aluminium anodisé noir

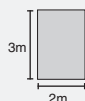

Medidas máx. de puerta
 Max. Sizes of doors
 Dimensions max. de porte

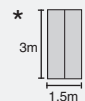

3m
1,5m



0 3m
1,5m

Añadir más kits según diseño
 Add more sets according to design
 Ajouter plus de kits selon design

Posibilidades de instalación | Installation possibilities | Possibilités d'installation

Conjunto marco perimetral a techo con vidrio fijo | Perimeter frame for fixed glass and ceiling kit
| Kit de cadre périmétral verre fixe et plafond

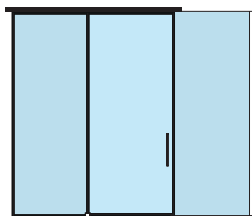
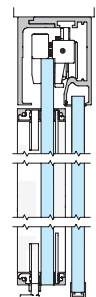

Conjunto perfil | Profile set | Jeu de profils

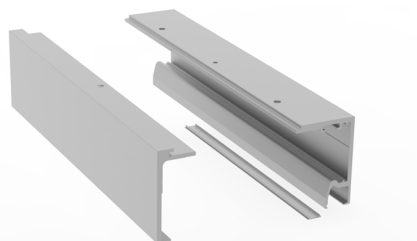

Conjunto perfil superior corredero con vidrio fijo para techo
Top track set with fixed panel.
Ceiling mount
Jeu rails de roulement avec verre fixe pour fixation à plafond



Finished	Cod		
S	0 109 22	2 m	1 juego 1 set 1 jeu
S	0 109 32	3 m	
S	0 109 42	4 m	
S	0 109 62	6 m	
BA	0 119 25	2 m	
BA	0 119 35	3 m	
BA	0 119 45	4 m	
BA	0 119 65	6 m	

Juegos | Sets | Jeux



Doble Freno retenedor
Double retaining break
2 freins de retenue

Cod. 0 109 00



Doble Anti-shock
Double Anti-shock
2 Anti-shock

Cod. 0 109 01

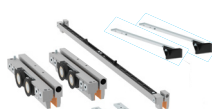

SOFTPRO doble
Double SOFTPRO
SOFTPRO double

Cod. 0 109 02



Freno retenedor + SOFTPRO simple
Retainig break + simple SOFTPRO
Frein de retenue + SOFTPRO simple

Cod. 0 109 03



Freno retenedor + Anti-shock
Retainig break + Anti-shock
Frein de retenue + Anti-shock

Cod. 0 109 04



Anti-shock + SOFTPRO simple
Anti-shock + simple SOFTPRO
Anti-shock + SOFTPRO simple

Cod. 0 109 05

Opciones frame | Options frame | Options frame

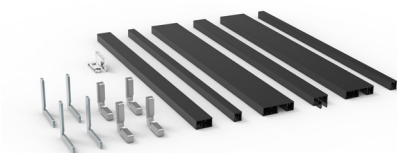

Conjunto marco perimetral
Perimeter frame set
Kit cadre périmétral



01 11 22



1 juego
1 set
1 jeu



01 11 27



Conjunto marco perimetral LED para vidrio fijo
LED perimeter frame for fixed glass
Cadre périmétral verre fixe LED



0 111 21



1 juego
1 set
1 jeu



0 111 26

Aluminio anodizado plata mate
Satin anodized aluminum
Aluminium anodisé argent



Aluminio anodizado negro
Black anodized aluminium
Aluminium anodisé noir

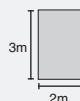

Medidas máx. de puerta
Max. Sizes of doors
Dimensions max. de porte

A photograph of a modern interior space featuring a glass partition wall. The floor is a mix of patterned tiles and wood. The text 'Diseño Design | Design' is overlaid in a blue diamond shape.

Diseño

Design | Design

Posibilidades de instalación | Installation possibilities | Possibilités d'installation

Conjunto marco perimetral a falso techo | False ceiling perimeter frame set
| Kit cadre périmétral pour faux plafond

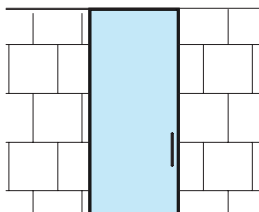
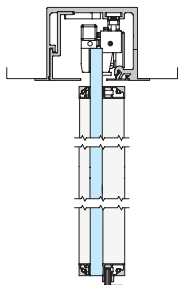

Conjunto perfil | Profile set | Jeu de profils

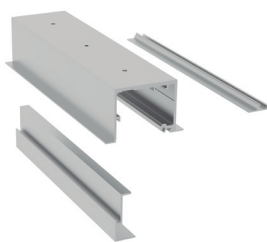

Conjunto perfil superior corredero falso techo con puerta corredera
Top track set for false ceiling
Set profil supérieur glissant pour faux plafond



Finished	Cod	المقياس	📦
S	0 109 24	2 m	1 juego 1 set 1 jeu
S	0 109 34	3 m	
S	0 109 44	4 m	
S	0 109 64	6 m	
BA	0 119 26	2 m	
BA	0 119 36	3 m	
BA	0 119 46	4 m	
BA	0 119 66	6 m	

Juegos | Sets | Jeux



Doble Freno retenedor
Double retaining break
2 freins de retenue
Cod. 0 109 00



Doble Anti-shock
Double Anti-shock
2 Anti-shock
Cod. 0 109 01



SOFTPRO doble
Double SOFTPRO
SOFTPRO double
Cod. 0 109 02

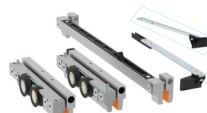

Freno retenedor + SOFTPRO simple
Retainig break + simple SOFTPRO
Frein de retenue + SOFTPRO simple
Cod. 0 109 03



Freno retenedor + Anti-shock
Retainig break + Anti-shock
Frein de retenue + Anti-shock
Cod. 0 109 04



Anti-shock + SOFTPRO simple
Anti-shock + simple SOFTPRO
Anti-shock + SOFTPRO simple
Cod. 0 109 05

Opciones frame | Options frame | Options frame

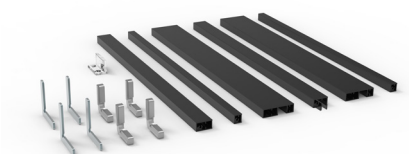

Conjunto marco perimetral
Perimeter frame set
Kit cadre périmétral

Finished	Cod	المقياس	📦
S	01 11 22		1 juego 1 set 1 jeu
BA	01 11 27		

Aluminio anodizado plata mate
Satin anodized aluminum
Aluminium anodisé argent



Aluminio anodizado negro
Black anodized aluminium
Aluminium anodisé noir

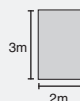

Medidas máx. de puerta
Max. Sizes of doors
Dimensions max. de porte

Posibilidades de instalación | Installation possibilities | Possibilités d'installation

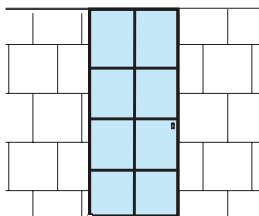
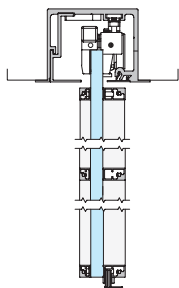
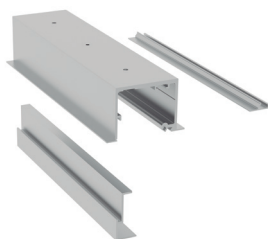
Conjunto división interna a falso techo | False ceiling internal division set
 | Kit division interne pour faux plafond

Conjunto perfil | Profile set | Jeu de profils

Conjunto perfil superior corredero
falso techo con puerta corredera
Top track set for false ceiling
Set profil supérieur glissant pour
faux plafond



Finished	Cod	Measure	Icon
S	0 109 24	2 m	1 juego 1 set 1 jeu
S	0 109 34	3 m	
S	0 109 44	4 m	
S	0 109 64	6 m	
BA	0 119 26	2 m	
BA	0 119 36	3 m	
BA	0 119 46	4 m	
BA	0 119 66	6 m	

Juegos | Sets | Jeux

Doble Freno retenedor
Double retaining break
2 freins de retenue
Cod. 0 109 00



Doble Anti-shock
Double Anti-shock
2 Anti-shock
Cod. 0 109 01

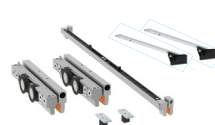

SOFTPRO doble
Double SOFTPRO
SOFTPRO double
Cod. 0 109 02



Freno retenedor +
SOFTPRO simple
Retainig break +
simple SOFTPRO
Frein de retenue +
SOFTPRO simple
Cod. 0 109 03



Freno retenedor +
Anti-shock
Retainig break +
Anti-shock
Frein de retenue +
Anti-shock
Cod. 0 109 04

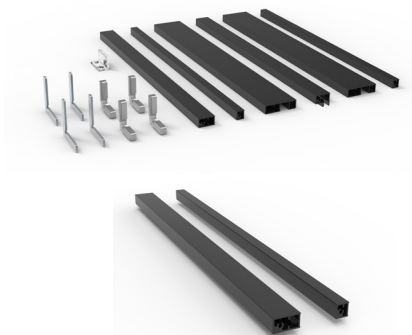

Anti-shock + SOFTPRO
simple
Anti-shock + simple
SOFTPRO
Anti-shock + SOFTPRO
simple
Cod. 0 109 05

Opciones frame | Options frame | Options frame

Conjunto marco perimetral
Perimeter frame set
Kit cadre périmétral

Conjunto división interna
Internal division set
Kit division interne

Finished	Cod	Measure	Icon
S	01 11 22	3 m 2 m	1 juego 1 set 1 jeu
BA	01 11 27		
S	01 11 20	3m*	1 juego 1 set 1 jeu
BA	01 11 25		

Aluminio anodizado plata mate
Satin anodized aluminum
Aluminium anodisé argent



Aluminio anodizado negro
Black anodized aluminium
Aluminium anodisé noir

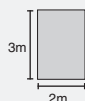

Medidas máx. de puerta
Max. Sizes of doors
Dimensions max. de porte

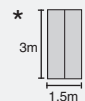

Añadir más kits según diseño
Add more sets according to design
Ajouter plus de kits selon design

Posibilidades de instalación | Installation possibilities | Possibilités d'installation

Conjunto marco perimetral a falso techo con vidrio fijo | False ceiling with fixed glass perimeter frame set
| Kit cadre périmétral pour faux plafond avec verre fixe

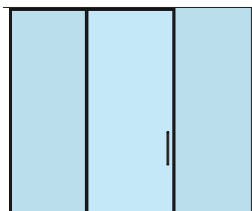
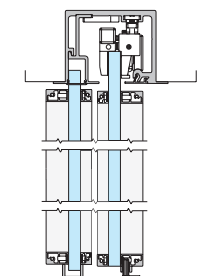

Conjunto perfil | Profile set | Jeu de profils

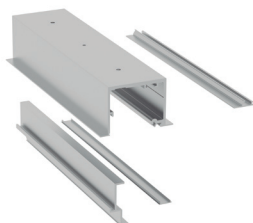

Conjunto perfil superior corredero falso techo puerta corredera con vidrio fijo
Top track set for false ceiling + Fixed glass
Set profil supérieur glissant pour faux plafond verre fixe



Finished	Cod	المقاس	📦
S	0 109 26	2 m	1 juego 1 set 1 jeu
S	0 109 36	3 m	
S	0 109 46	4 m	
S	0 109 66	6 m	
BA	0 119 27	2 m	
BA	0 119 37	3 m	
BA	0 119 47	4 m	
BA	0 119 67	6 m	

Juegos | Sets | Jeux



Doble Freno retenedor
Double retaining break
2 freins de retenue
Cod. 0 109 00



Doble Anti-shock
Double Anti-shock
2 Anti-shock
Cod. 0 109 01

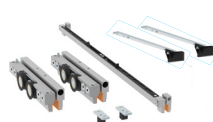

SOFTPRO doble
Double SOFTPRO
SOFTPRO double
Cod. 0 109 02



Freno retenedor + SOFTPRO simple
Retainig break + simple SOFTPRO
Frein de retenue + SOFTPRO simple
Cod. 0 109 03



Freno retenedor + Anti-shock
Retainig break + Anti-shock
Frein de retenue + Anti-shock
Cod. 0 109 04

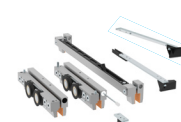

Anti-shock + SOFTPRO simple
Anti-shock + simple SOFTPRO
Anti-shock + SOFTPRO simple
Cod. 0 109 05

Opciones frame | Options frame | Options frame



Conjunto marco perimetral
Perimeter frame set
Kit cadre périmétral

Conjunto marco perimetral vidrio fijo falso techo
Perimeter frame for fixed glass and false ceiling kit
Kit de cadre périmétral verre fixe et faux plafond

Finished	Cod	المقاس	📦
S	01 11 22	3 m 2 m	1 juego 1 set 1 jeu
BA	01 11 27		
S	01 11 28	3 m 2 m	1 juego 1 set 1 jeu
BA	01 11 29		

Aluminio anodizado plata mate
Satin anodized aluminum
Aluminium anodisé argent



Aluminio anodizado negro
Black anodized aluminium
Aluminium anodisé noir

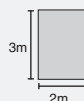

Medidas máx. de puerta
Max. Sizes of doors
Dimensions max. de porte

Posibilidades de instalación | Installation possibilities | Possibilités d'installation

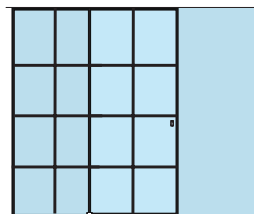
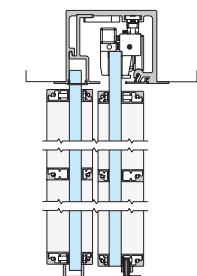
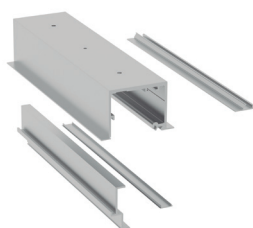
Conjunto división interna a falso techo con pared de vidrio | False ceiling with fixed glass internal division set
 | Kit division interne pour faux plafond avec verre fixe

Conjunto perfil | Profile set | Jeu de profils

Conjunto perfil superior corredero
 falso techo puerta corredera con
 vidrio fijo
 Top track set for false ceiling +
 Fixed glass
 Set profil supérieur glissant pour
 faux plafond verre fixe



Finished	Cod	Length	Quantity
S	0 109 26	2 m	1 juego 1 set 1 jeu
S	0 109 36	3 m	
S	0 109 46	4 m	
S	0 109 66	6 m	
BA	0 119 27	2 m	
BA	0 119 37	3 m	
BA	0 119 47	4 m	
BA	0 119 67	6 m	

Juegos | Sets | Jeux

Doble Freno retenedor
 Double retaining break
 2 freins de retenue

Cod. 0 109 00



Doble Anti-shock
 Double Anti-shock
 2 Anti-shock

Cod. 0 109 01



SOFTPRO doble
 Double SOFTPRO
 SOFTPRO double

Cod. 0 109 02



Freno retenedor +
 SOFTPRO simple
 Retainig break +
 simple SOFTPRO
 Frein de retenue +
 SOFTPRO simple

Cod. 0 109 03



Freno retenedor +
 Anti-shock
 Retainig break +
 Anti-shock
 Frein de retenue +
 Anti-shock

Cod. 0 109 04



Anti-shock + SOFTPRO
 simple
 Anti-shock + simple
 SOFTPRO
 Anti-shock + SOFTPRO
 simple

Cod. 0 109 05

Opciones frame | Options frame | Options frame

Finished	Cod	Dimensions	Quantity
S	01 11 22	3 m 2 m	1 juego 1 set 1 jeu
BA	01 11 27		
S	01 11 20	3m*	1 juego 1 set 1 jeu
BA	01 11 25		
S	01 11 28	3 m 2 m	1 juego 1 set 1 jeu
BA	01 11 29		

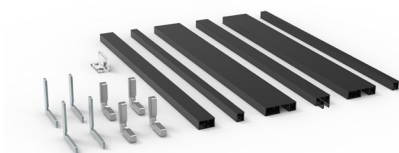

Conjunto marco perimetral
 Perimeter frame set
 Kit cadre périmétral

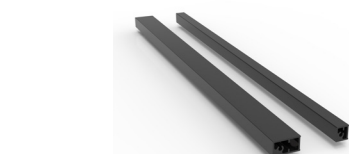

Conjunto división interna
 Internal division set
 Kit division interne

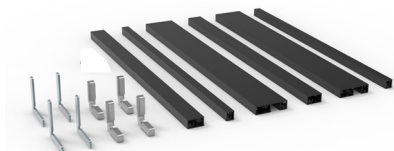

Conjunto marco perimetral vidrio
 fijo falso techo
 Perimeter frame for fixed glass
 and false ceiling kit
 Kit de cadre périmétral verre fixe
 et faux plafond

Aluminio anodizado plata mate
 Satin anodized aluminum
 Aluminium anodisé argent



Aluminio anodizado negro
 Black anodized aluminum
 Aluminium anodisé noir

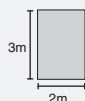

Medidas máx. de puerta
 Max. Sizes of doors
 Dimensions max. de porte

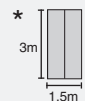

Añadir más kits según diseño
 Add more sets according to design
 Ajouter plus de kits selon design

Polígono Industrial de Foradada / 08580
St. Quirze de Besora / Barcelona / Spain
T +34 93 852 92 23
saheco@saheco.com

Export contact details
T +34 93 852 96 15
export@saheco.com
saheco.com



+ info saheco.com

